

# User Manual



## Integrated Measurement System

**R&S® IMS**  
1502.0009.02/04

Printed in Germany



**Dear Customer,**

When referring to your Integrated Measurement System R&S<sup>®</sup> IMS the abbreviation R&S IMS is used throughout this operating manual.

R&S<sup>®</sup> is a registered trade name of ROHDE & SCHWARZ GmbH & Co. KG.  
Proper names are trade marks of their respective owners.

# Overview of Chapters

**General****Contents****Data Sheet**

Safety Instructions

CE Certificate of Quality

EU Declaration of Conformity

Support Center Address

List of Rohde &amp; Schwarz Offices

**Chapter 1****Putting into Operation****Chapter 2****Manual Operation****Chapter 3****Instrument Functions****Chapter 4****Applications****Chapter 5****Examples of Measurements****Chapter 6****Instrument Interfaces, Maintenance, Errors****Chapter 7****Manual for Integrated Amplifier (valid only for variant 04)****Chapter 8****Index**



## Contents

RF frequency.....	1
Spectral purity .....	1
RF level.....	1
LF generator.....	1
Modulation .....	1
Inputs to generator.....	2
Outputs from generator .....	2
General transmission data .....	3
Interfaces.....	3
Path switching .....	3
Frequency .....	4
Amplitude .....	4
Inputs.....	5
Further R&S IMS interfaces.....	5
Power supply .....	6
General data.....	6
<b>1 Putting into Operation .....</b>	<b>1</b>
<b>1.1 Front Panel.....</b>	<b>2</b>
<b>1.2 Rear Panel.....</b>	<b>7</b>
<b>1.3 Putting into Operation .....</b>	<b>13</b>
1.3.1 Unpacking the R&S IMS.....	13
1.3.2 Setting up the Instrument or Installing it in a 19" Rack .....	13
1.3.3 Safety Instructions.....	14
1.3.3.1 Safety Precautions against Electrostatic Discharge .....	14
1.3.3.2 Installing the Instrument.....	14
1.3.3.3 EMC Safety Precautions.....	14
1.3.4 Connecting the R&S IMS to the AC Supply .....	15
1.3.5 Switching On the R&S IMS .....	15
1.3.6 Power-up Actions of the R&S IMS .....	16
1.3.7 Switching Off .....	16
<b>1.4 Function Checks .....</b>	<b>17</b>
<b>1.5 Connecting the Power Sensor.....</b>	<b>17</b>
<b>1.6 Connecting Amplifiers.....</b>	<b>17</b>
<b>1.7 Connecting EUT Monitoring.....</b>	<b>19</b>
<b>1.8 Installing the Operating System .....</b>	<b>20</b>
<b>1.9 Registering the License.....</b>	<b>20</b>
<b>1.10 Installing the EMC32 Software.....</b>	<b>21</b>
1.10.1 System Requirements .....	21

1.10.2	Data Security and User Administration .....	21
1.10.3	Simplified User Administration .....	21
<b>1.11</b>	<b>Installing the Software.....</b>	<b>22</b>
1.11.1	Installing the R&S IMS Operating System .....	22
1.11.2	Installing USB Device Drivers .....	23
<b>1.12</b>	<b>Starting the Program .....</b>	<b>26</b>
<b>1.13</b>	<b>EMC32 - IMS Configuration .....</b>	<b>27</b>
<b>1.14</b>	<b>Updating the EMC32 Software.....</b>	<b>28</b>
<b>1.15</b>	<b>Uninstalling the EMC32 Software.....</b>	<b>29</b>
<b>1.16</b>	<b>Network Installation Tips.....</b>	<b>30</b>
<b>1.17</b>	<b>Data Backup Instructions.....</b>	<b>31</b>
<b>1.18</b>	<b>Troubleshooting.....</b>	<b>32</b>
<b>2</b>	<b>Manual Operation.....</b>	<b>2</b>
2.1	Manual Operation.....	2
<b>3</b>	<b>Instrument Functions.....</b>	<b>2</b>
3.1	Introduction .....	2
3.2	Instrument Functions .....	2
<b>4</b>	<b>Applications.....</b>	<b>1</b>
4.1	Introduction .....	1
4.2	Applications.....	1
4.2.1	Commercial Standards.....	1
4.2.2	Military Standards.....	4
4.2.3	Automotive Standards .....	5
<b>5</b>	<b>Examples of Measurements .....</b>	<b>1</b>
5.1	Introduction .....	1
5.2	Measurement to EN 61000-4-3 (Radiated) .....	1
5.2.1	Test Setup for External Dual Band Amplifiers.....	1
5.2.2	Configuring the Software for Dual Band Amplifiers.....	3
5.2.3	Signal Path Calibration for Dual Band Amplifiers.....	6
5.2.4	Test Setup for Two External Amplifiers .....	8
5.2.5	Configuring the Software for Two External Amplifiers .....	9
5.2.6	Signal Path Calibration for Two External Amplifiers .....	12
5.2.7	Reference Calibration with Field Uniformity Evaluation of the Log-Periodic Antenna .....	14
5.2.8	Equipment Test with EUT Monitoring.....	14
5.3	Measurement to EN 61000-4-6 (Conducted) with CDN.....	15
5.3.1	Test Setup .....	15
5.3.2	Software Configuration.....	16
5.3.3	Signal Path Calibration.....	20
5.3.4	Reference Calibration of Coupling/Decoupling Networks .....	22
5.3.5	Equipment Test with Coupling/Decoupling Network and EUT Monitoring.....	22

---

<b>6 Instrument Interfaces, Maintenance, Errors .....</b>	<b>2</b>
<b>6.1 Introduction .....</b>	<b>2</b>
<b>6.2 Instrument Interfaces.....</b>	<b>2</b>
<b>7 Amplifier Manual .....</b>	<b>9</b>
<b>7.1 Preparation for Use .....</b>	<b>9</b>
7.1.1 Setting up the amplifier.....	10
7.1.2 Rack mounting .....	10
7.1.3 Mains connection .....	10
7.1.4 RF connectors .....	10
7.1.5 Interlock safety loop .....	11
<b>7.2 Functional Description .....</b>	<b>13</b>
7.2.1 RF amplifier .....	13
7.2.2 Power supply .....	14
7.2.3 Monitor output (Option A).....	15
7.2.4 USB remote control interface (Option U) .....	15
7.2.5 Control .....	15
<b>7.3 Maintenance and Troubleshooting .....</b>	<b>16</b>
7.3.1 Maintenance .....	16
7.3.2 Troubleshooting.....	16
<b>8 Index.....</b>	<b>1</b>







**Before putting the product into operation for the first time, make sure to read the following**



# Safety Instructions

Rohde & Schwarz makes every effort to keep the safety standard of its products up to date and to offer its customers the highest possible degree of safety. Our products and the auxiliary equipment required for them are designed and tested in accordance with the relevant safety standards. Compliance with these standards is continuously monitored by our quality assurance system. This product has been designed and tested in accordance with the EC Certificate of Conformity and has left the manufacturer's plant in a condition fully complying with safety standards. To maintain this condition and to ensure safe operation, observe all instructions and warnings provided in this manual. If you have any questions regarding these safety instructions, Rohde & Schwarz will be happy to answer them.

Furthermore, it is your responsibility to use the product in an appropriate manner. This product is designed for use solely in industrial and laboratory environments or in the field and must not be used in any way that may cause personal injury or property damage. You are responsible if the product is used for an intention other than its designated purpose or in disregard of the manufacturer's instructions. The manufacturer shall assume no responsibility for such use of the product.

The product is used for its designated purpose if it is used in accordance with its operating manual and within its performance limits (see data sheet, documentation, the following safety instructions). Using the products requires technical skills and knowledge of English. It is therefore essential that the products be used exclusively by skilled and specialized staff or thoroughly trained personnel with the required skills. If personal safety gear is required for using Rohde & Schwarz products, this will be indicated at the appropriate place in the product documentation.

## Symbols and safety labels

Observe operating instructions	Weight indication for units >18 kg	Danger of electric shock	Warning! Hot surface	PE terminal	Ground	Ground terminal	Attention! Electrostatic sensitive devices

Supply voltage ON/OFF	Standby indication	Direct current (DC)	Alternating current (AC)	Direct/alternating current (DC/AC)	Device fully protected by double/reinforced insulation

## Safety Instructions

Observing the safety instructions will help prevent personal injury or damage of any kind caused by dangerous situations. Therefore, carefully read through and adhere to the following safety instructions before putting the product into operation. It is also absolutely essential to observe the additional safety instructions on personal safety that appear in other parts of the documentation. In these safety instructions, the word "product" refers to all merchandise sold and distributed by Rohde & Schwarz, including instruments, systems and all accessories.

### Tags and their meaning

DANGER	This tag indicates a safety hazard with a high potential of risk for the user that can result in death or serious injuries.
WARNING	This tag indicates a safety hazard with a medium potential of risk for the user that can result in death or serious injuries.
CAUTION	This tag indicates a safety hazard with a low potential of risk for the user that can result in slight or minor injuries.
ATTENTION	This tag indicates the possibility of incorrect use that can cause damage to the product.
NOTE	This tag indicates a situation where the user should pay special attention to operating the product but which does not lead to damage.

These tags are in accordance with the standard definition for civil applications in the European Economic Area. Definitions that deviate from the standard definition may also exist. It is therefore essential to make sure that the tags described here are always used only in connection with the associated documentation and the associated product. The use of tags in connection with unassociated products or unassociated documentation can result in misinterpretations and thus contribute to personal injury or material damage.

### Basic safety instructions

1. The product may be operated only under the operating conditions and in the positions specified by the manufacturer. Its ventilation must not be obstructed during operation. Unless otherwise specified, the following requirements apply to Rohde & Schwarz products:  
prescribed operating position is always with the housing floor facing down, IP protection 2X, pollution severity 2, overvoltage category 2, use only in enclosed spaces, max. operation altitude max. 2000 m. Unless specified otherwise in the data sheet, a tolerance of  $\pm 10\%$  shall apply to the nominal voltage and of  $\pm 5\%$  to the nominal frequency.
2. Applicable local or national safety regulations and rules for the prevention of accidents must be observed in all work performed. The product may be opened only by authorized, specially trained personnel. Prior to performing any work on the product or opening the product, the product must be disconnected from the supply network. Any adjustments, replacements of parts, maintenance or repair must be carried out only by technical personnel authorized by Rohde & Schwarz. Only original parts may be used for replacing parts relevant to safety (e.g. power switches, power transformers, fuses). A safety test must always be performed after parts relevant to safety have been replaced (visual inspection, PE conductor test, insulation resistance measurement, leakage current measurement, functional test).
3. As with all industrially manufactured goods, the use of substances that induce an allergic reaction (allergens, e.g. nickel) such as aluminum cannot be generally excluded. If you develop an allergic reaction (such as a skin rash, frequent sneezing, red eyes or respiratory difficulties), consult a physician immediately to determine the cause.

## Safety Instructions

4. If products/components are mechanically and/or thermally processed in a manner that goes beyond their intended use, hazardous substances (heavy-metal dust such as lead, beryllium, nickel) may be released. For this reason, the product may only be disassembled, e.g. for disposal purposes, by specially trained personnel. Improper disassembly may be hazardous to your health. National waste disposal regulations must be observed.
5. If handling the product yields hazardous substances or fuels that must be disposed of in a special way, e.g. coolants or engine oils that must be replenished regularly, the safety instructions of the manufacturer of the hazardous substances or fuels and the applicable regional waste disposal regulations must be observed. Also observe the relevant safety instructions in the product documentation.
6. Depending on the function, certain products such as RF radio equipment can produce an elevated level of electromagnetic radiation. Considering that unborn life requires increased protection, pregnant women should be protected by appropriate measures. Persons with pacemakers may also be endangered by electromagnetic radiation. The employer is required to assess workplaces where there is a special risk of exposure to radiation and, if necessary, take measures to avert the danger.
7. Operating the products requires special training and intense concentration. Make certain that persons who use the products are physically, mentally and emotionally fit enough to handle operating the products; otherwise injuries or material damage may occur. It is the responsibility of the employer to select suitable personnel for operating the products.
8. Prior to switching on the product, it must be ensured that the nominal voltage setting on the product matches the nominal voltage of the AC supply network. If a different voltage is to be set, the power fuse of the product may have to be changed accordingly.
9. In the case of products of safety class I with movable power cord and connector, operation is permitted only on sockets with earthing contact and protective earth connection.
10. Intentionally breaking the protective earth connection either in the feed line or in the product itself is not permitted. Doing so can result in the danger of an electric shock from the product. If extension cords or connector strips are implemented, they must be checked on a regular basis to ensure that they are safe to use.
11. If the product has no power switch for disconnection from the AC supply, the plug of the connecting cable is regarded as the disconnecting device. In such cases, it must be ensured that the power plug is easily reachable and accessible at all times (length of connecting cable approx. 2 m). Functional or electronic switches are not suitable for providing disconnection from the AC supply. If products without power switches are integrated in racks or systems, a disconnecting device must be provided at the system level.
12. Never use the product if the power cable is damaged. By taking appropriate safety measures and carefully laying the power cable, ensure that the cable cannot be damaged and that no one can be hurt by e.g. tripping over the cable or suffering an electric shock.
13. The product may be operated only from TN/TT supply networks fused with max. 16 A.
14. Do not insert the plug into sockets that are dusty or dirty. Insert the plug firmly and all the way into the socket. Otherwise this can result in sparks, fire and/or injuries.
15. Do not overload any sockets, extension cords or connector strips; doing so can cause fire or electric shocks.
16. For measurements in circuits with voltages  $V_{rms} > 30 V$ , suitable measures (e.g. appropriate measuring equipment, fusing, current limiting, electrical separation, insulation) should be taken to avoid any hazards.
17. Ensure that the connections with information technology equipment comply with IEC 950/EN 60950.
18. Never remove the cover or part of the housing while you are operating the product. This will expose circuits and components and can lead to injuries, fire or damage to the product.

## Safety Instructions

19. If a product is to be permanently installed, the connection between the PE terminal on site and the product's PE conductor must be made first before any other connection is made. The product may be installed and connected only by a skilled electrician.
20. For permanently installed equipment without built-in fuses, circuit breakers or similar protective devices, the supply circuit must be fused in such a way that suitable protection is provided for users and products.
21. Do not insert any objects into the openings in the housing that are not designed for this purpose. Never pour any liquids onto or into the housing. This can cause short circuits inside the product and/or electric shocks, fire or injuries.
22. Use suitable overvoltage protection to ensure that no overvoltage (such as that caused by a thunderstorm) can reach the product. Otherwise the operating personnel will be endangered by electric shocks.
23. Rohde & Schwarz products are not protected against penetration of water, unless otherwise specified (see also safety instruction 1.). If this is not taken into account, there exists the danger of electric shock or damage to the product, which can also lead to personal injury.
24. Never use the product under conditions in which condensation has formed or can form in or on the product, e.g. if the product was moved from a cold to a warm environment.
25. Do not close any slots or openings on the product, since they are necessary for ventilation and prevent the product from overheating. Do not place the product on soft surfaces such as sofas or rugs or inside a closed housing, unless this is well ventilated.
26. Do not place the product on heat-generating devices such as radiators or fan heaters. The temperature of the environment must not exceed the maximum temperature specified in the data sheet.
27. Batteries and storage batteries must not be exposed to high temperatures or fire. Keep batteries and storage batteries away from children. If batteries or storage batteries are improperly replaced, this can cause an explosion (warning: lithium cells). Replace the battery or storage battery only with the matching Rohde & Schwarz type (see spare parts list). Batteries and storage batteries are hazardous waste. Dispose of them only in specially marked containers. Observe local regulations regarding waste disposal. Do not short-circuit batteries or storage batteries.
28. Please be aware that in the event of a fire, toxic substances (gases, liquids etc.) that may be hazardous to your health may escape from the product.
29. Please be aware of the weight of the product. Be careful when moving it; otherwise you may injure your back or other parts of your body.
30. Do not place the product on surfaces, vehicles, cabinets or tables that for reasons of weight or stability are unsuitable for this purpose. Always follow the manufacturer's installation instructions when installing the product and fastening it to objects or structures (e.g. walls and shelves).
31. Handles on the products are designed exclusively for personnel to hold or carry the product. It is therefore not permissible to use handles for fastening the product to or on means of transport such as cranes, fork lifts, wagons, etc. The user is responsible for securely fastening the products to or on the means of transport and for observing the safety regulations of the manufacturer of the means of transport. Noncompliance can result in personal injury or material damage.
32. If you use the product in a vehicle, it is the sole responsibility of the driver to drive the vehicle safely. Adequately secure the product in the vehicle to prevent injuries or other damage in the event of an accident. Never use the product in a moving vehicle if doing so could distract the driver of the vehicle. The driver is always responsible for the safety of the vehicle; the manufacturer assumes no responsibility for accidents or collisions.
33. If a laser product (e.g. a CD/DVD drive) is integrated in a Rohde & Schwarz product, do not use any other settings or functions than those described in the documentation. Otherwise this may be hazardous to your health, since the laser beam can cause irreversible damage to your eyes. Never try to take such products apart, and never look into the laser beam.



**Por favor lea imprescindiblemente antes de la primera puesta en funcionamiento las siguientes informaciones de seguridad**



## Informaciones de seguridad

Es el principio de Rohde & Schwarz de tener a sus productos siempre al día con los standards de seguridad y de ofrecer a sus clientes el máximo grado de seguridad. Nuestros productos y todos los equipos adicionales son siempre fabricados y examinados según las normas de seguridad vigentes. Nuestra sección de gestión de la seguridad de calidad controla constantemente que sean cumplidas estas normas. Este producto ha sido fabricado y examinado según el comprobante de conformidad adjunto según las normas de la CE y ha salido de nuestra planta en estado impecable según los standards técnicos de seguridad. Para poder preservar este estado y garantizar un funcionamiento libre de peligros, deberá el usuario atenerse a todas las informaciones, informaciones de seguridad y notas de alerta. Rohde&Schwarz está siempre a su disposición en caso de que tengan preguntas referentes a estas informaciones de seguridad.

Además queda en la responsabilidad del usuario utilizar el producto en la forma debida. Este producto solamente fue elaborado para ser utilizado en la industria y el laboratorio o para fines de campo y de ninguna manera deberá ser utilizado de modo que alguna persona/cosa pueda ser dañada. El uso del producto fuera de sus fines definidos o despreciando las informaciones de seguridad del fabricante queda en la responsabilidad del usuario. El fabricante no se hace en ninguna forma responsable de consecuencias a causa del maluso del producto.

Se parte del uso correcto del producto para los fines definidos si el producto es utilizado dentro de las instrucciones del correspondiente manual del uso y dentro del margen de rendimiento definido (ver hoja de datos, documentación, informaciones de seguridad que siguen). El uso de los productos hace necesarios conocimientos profundos y el conocimiento del idioma inglés. Por eso se deberá tener en cuenta de exclusivamente autorizar para el uso de los productos a personas péritas o debidamente minuciosamente instruidas con los conocimientos citados. Si fuera necesaria indumentaria de seguridad para el uso de productos de R&S, encontrará la información debida en la documentación del producto en el capítulo correspondiente.

### Símbolos y definiciones de seguridad

Ver manual de instrucciones del uso	Informaciones para maquinaria con un peso de > 18kg	Peligro de golpe de corriente	¡Advertencia! Superficie caliente	Conexión a conductor protector	Conexión a tierra	Conexión a masa conductora	¡Cuidado! Elementos de construcción con peligro de carga electrostática

potencia EN MARCHA/PARADA	Indicación Stand-by	Corriente continua DC	Corriente alterna AC	Corriente continua/alterna DC/AC	El aparato está protegido en su totalidad por un aislamiento de doble refuerzo

## Informaciones de seguridad

Tener en cuenta las informaciones de seguridad sirve para tratar de evitar daños y peligros de toda clase. Es necesario de que se lean las siguientes informaciones de seguridad concienzudamente y se tengan en cuenta debidamente antes de la puesta en funcionamiento del producto. También deberán ser tenidas en cuenta las informaciones para la protección de personas que encontrarán en otro capítulo de esta documentación y que también son obligatorias de seguir. En las informaciones de seguridad actuales hemos juntado todos los objetos vendidos por Rohde&Schwarz bajo la denominación de „producto“, entre ellos también aparatos, instalaciones así como toda clase de accesorios.

### Palabras de señal y su significado

PELIGRO	Indica un punto de peligro con gran potencial de riesgo para el usuario. Punto de peligro que puede llevar hasta la muerte o graves heridas.
ADVERTENCIA	Indica un punto de peligro con un potencial de riesgo mediano para el usuario. Punto de peligro que puede llevar hasta la muerte o graves heridas .
ATENCIÓN	Indica un punto de peligro con un potencial de riesgo pequeño para el usuario. Punto de peligro que puede llevar hasta heridas leves o pequeñas
CUIDADO	Indica la posibilidad de utilizar mal el producto y a consecuencia dañarlo.
INFORMACIÓN	Indica una situación en la que deberían seguirse las instrucciones en el uso del producto, pero que no consecuentemente deben de llevar a un daño del mismo.

Las palabras de señal corresponden a la definición habitual para aplicaciones civiles en el ámbito de la comunidad económica europea. Pueden existir definiciones diferentes a esta definición. Por eso se debiera tener en cuenta que las palabras de señal aquí descritas sean utilizadas siempre solamente en combinación con la correspondiente documentación y solamente en combinación con el producto correspondiente. La utilización de las palabras de señal en combinación con productos o documentaciones que no les correspondan puede llevar a malinterpretaciones y tener por consecuencia daños en personas u objetos.

### Informaciones de seguridad elementales

1. El producto solamente debe ser utilizado según lo indicado por el fabricante referente a la situación y posición de funcionamiento sin que se obstruya la ventilación. Si no se convino de otra manera, es para los productos R&S válido lo que sigue: como posición de funcionamiento se define principalmente la posición con el suelo de la caja para abajo , modo de protección IP 2X, grado de suciedad 2, categoría de sobrecarga eléctrica 2, utilizar solamente en estancias interiores, utilización hasta 2000 m sobre el nivel del mar.  
A menos que se especifique otra cosa en la hoja de datos, se aplicará una tolerancia de  $\pm 10\%$  sobre el voltaje nominal y de  $\pm 5\%$  sobre la frecuencia nominal.
2. En todos los trabajos deberán ser tenidas en cuenta las normas locales de seguridad de trabajo y de prevención de accidentes. El producto solamente debe de ser abierto por personal périto autorizado. Antes de efectuar trabajos en el producto o abrirlo deberá este ser desconectado de la corriente. El ajuste, el cambio de partes, la manutención y la reparación deberán ser solamente efectuadas por electricistas autorizados por R&S. Si se reponen partes con importancia para los aspectos de seguridad (por ejemplo el enchufe, los transformadores o los fusibles), solamente podrán ser sustituidos por partes originales. Despues de cada recambio de partes elementales para la seguridad deberá ser efectuado un control de

## Informaciones de seguridad

- seguridad (control a primera vista, control de conductor protector, medición de resistencia de aislamiento, medición de medición de la corriente conductora, control de funcionamiento).
3. Como en todo producto de fabricación industrial no puede ser excluido en general de que se produzcan al usarlo elementos que puedan generar alergias, los llamados elementos alergénicos (por ejemplo el níquel). Si se produjeran en el trato con productos R&S reacciones alérgicas, como por ejemplo urticaria, estornudos frecuentes, irritación de la conjuntiva o dificultades al respirar, se deberá consultar inmediatamente a un médico para averiguar los motivos de estas reacciones.
  4. Si productos / elementos de construcción son tratados fuera del funcionamiento definido de forma mecánica o térmica, pueden generarse elementos peligrosos (polvos de sustancia de metales pesados como por ejemplo plomo, berilio, níquel). La partición elemental del producto, como por ejemplo sucede en el tratamiento de materias residuales, debe de ser efectuada solamente por personal especializado para estos tratamientos. La partición elemental efectuada inadecuadamente puede generar daños para la salud. Se deben tener en cuenta las directivas nacionales referentes al tratamiento de materias residuales.
  5. En el caso de que se produjeran agentes de peligro o combustibles en la aplicación del producto que debieran de ser transferidos a un tratamiento de materias residuales, como por ejemplo agentes refrigerantes que deben ser repuestos en periodos definidos, o aceites para motores, deberán ser tenidas en cuenta las prescripciones de seguridad del fabricante de estos agentes de peligro o combustibles y las regulaciones regionales para el tratamiento de materias residuales. Cuiden también de tener en cuenta en caso dado las prescripciones de seguridad especiales en la descripción del producto.
  6. Ciertos productos, como por ejemplo las instalaciones de radiación HF, pueden a causa de su función natural, emitir una radiación electromagnética aumentada. En vista a la protección de la vida en desarrollo deberían ser protegidas personas embarazadas debidamente. También las personas con un bypass pueden correr peligro a causa de la radiación electromagnética. El empresario está comprometido a valorar y señalar áreas de trabajo en las que se corra un riesgo de exposición a radiaciones aumentadas de riesgo aumentado para evitar riesgos.
  7. La utilización de los productos requiere instrucciones especiales y una alta concentración en el manejo. Debe de ponerse por seguro de que las personas que manejen los productos estén a la altura de los requerimientos necesarios referente a sus aptitudes físicas, psíquicas y emocionales, ya que de otra manera no se pueden excluir lesiones o daños de objetos. El empresario lleva la responsabilidad de seleccionar el personal usuario apto para el manejo de los productos.
  8. Antes de la puesta en marcha del producto se deberá tener por seguro de que la tensión preseleccionada en el producto equivalga a la del la red de distribución. Si es necesario cambiar la preselección de la tensión también se deberán en caso dabo cambiar los fusibles correspondientes del producto.
  9. Productos de la clase de seguridad I con alimentación móvil y enchufe individual de producto solamente deberán ser conectados para el funcionamiento a tomas de corriente de contacto de seguridad y con conductor protector conectado.
  10. Queda prohibida toda clase de interrupción intencionada del conductor protector, tanto en la toma de corriente como en el mismo producto ya que puede tener como consecuencia el peligro de golpe de corriente por el producto. Si se utilizaran cables o enchufes de extensión se deberá poner al seguro, que es controlado su estado técnico de seguridad.
  11. Si el producto no está equipado con un interruptor para desconectarlo de la red, se deberá considerar el enchufe del cable de distribución como interruptor. En estos casos deberá asegurar de que el enchufe sea de fácil acceso y nabejo (medida del cable de distribución aproximadamente 2 m). Los interruptores de función o electrónicos no son aptos para el corte de la red eléctrica. Si los productos sin interruptor están integrados en construcciones o instalaciones, se deberá instalar el interruptor al nivel de la instalación.

## Informaciones de seguridad

12. No utilice nunca el producto si está dañado el cable eléctrico. Asegure a través de las medidas de protección y de instalación adecuadas de que el cable de eléctrico no pueda ser dañado o de que nadie pueda ser dañado por él, por ejemplo al tropezar o por un golpe de corriente.
13. Solamente está permitido el funcionamiento en redes de distribución TN/TT aseguradas con fusibles de como máximo 16 A.
14. Nunca conecte el enchufe en tomas de corriente sucias o llenas de polvo. Introduzca el enchufe por completo y fuertemente en la toma de corriente. Si no tiene en consideración estas indicaciones se arriesga a que se originen chispas, fuego y/o heridas.
15. No sobrecargue las tomas de corriente, los cables de extensión o los enchufes de extensión ya que esto pudiera causar fuego o golpes de corriente.
16. En las mediciones en circuitos de corriente con una tensión de entrada de  $U_{eff} > 30 \text{ V}$  se deberá tomar las precauciones debidas para impedir cualquier peligro (por ejemplo medios de medición adecuados, seguros, limitación de tensión, corte protector, aislamiento etc.).
17. En caso de conexión con aparatos de la técnica informática se deberá tener en cuenta que estos cumplan los requisitos de la EC950/EN60950.
18. Nunca abra la tapa o parte de ella si el producto está en funcionamiento. Esto pone a descubierto los cables y componentes eléctricos y puede causar heridas, fuego o daños en el producto.
19. Si un producto es instalado fijamente en un lugar, se deberá primero conectar el conductor protector fijo con el conductor protector del aparato antes de hacer cualquier otra conexión. La instalación y la conexión deberán ser efectuadas por un electricista especializado.
20. En caso de que los productos que son instalados fijamente en un lugar sean sin protector implementado, autointerruptor o similares objetos de protección, deberá la toma de corriente estar protegida de manera que los productos o los usuarios estén suficientemente protegidos.
21. Por favor, no introduzca ningún objeto que no esté destinado a ello en los orificios de la caja del aparato. No vierta nunca ninguna clase de líquidos sobre o en la caja. Esto puede producir corto circuitos en el producto y/o puede causar golpes de corriente, fuego o heridas.
22. Asegúrese con la protección adecuada de que no pueda originarse en el producto una sobrecarga por ejemplo a causa de una tormenta. Si no se verá el personal que lo utilice expuesto al peligro de un golpe de corriente.
23. Los productos R&S no están protegidos contra el agua si no es que exista otra indicación, ver también punto 1. Si no se tiene en cuenta esto se arriesga el peligro de golpe de corriente o de daños en el producto lo cual también puede llevar al peligro de personas.
24. No utilice el producto bajo condiciones en las que pueda producirse y se hayan producido líquidos de condensación en o dentro del producto como por ejemplo cuando se desplaza el producto de un lugar frío a un lugar caliente.
25. Por favor no cierre ninguna ranura u orificio del producto, ya que estas son necesarias para la ventilación e impiden que el producto se caliente demasiado. No pongan el producto encima de materiales blandos como por ejemplo sofás o alfombras o dentro de una caja cerrada, si esta no está suficientemente ventilada.
26. No ponga el producto sobre aparatos que produzcan calor, como por ejemplo radiadores o calentadores. La temperatura ambiental no debe superar la temperatura máxima especificada en la hoja de datos.



## Informaciones de seguridad

27. Baterías y acumuladores no deben de ser expuestos a temperaturas altas o al fuego. Guardar baterías y acumuladores fuera del alcance de los niños. Si las baterías o los acumuladores no son cambiados con la debida atención existirá peligro de explosión (atención celulas de Litio). Cambiar las baterías o los acumuladores solamente por los del tipo R&S correspondiente (ver lista de piezas de recambio). Baterías y acumuladores son deshechos problemáticos. Por favor tirenlos en los recipientes especiales para este fin. Por favor tengan en cuenta las prescripciones nacionales de cada país referente al tratamiento de deshechos. Nunca sometan las baterías o acumuladores a un corto circuito.
28. Tengan en consideración de que en caso de un incendio pueden escaparse gases tóxicos del producto, que pueden causar daños a la salud.
29. Por favor tengan en cuenta que en caso de un incendio pueden desprenderse del producto agentes venenosos (gases, líquidos etc.) que pueden generar daños a la salud.
30. No sitúe el producto encima de superficies, vehículos, estantes o mesas, que por sus características de peso o de estabilidad no sean aptas para él. Siga siempre las instrucciones de instalación del fabricante cuando instale y asegure el producto en objetos o estructuras (por ejemplo paredes y estantes).
31. Las asas instaladas en los productos sirven solamente de ayuda para el manejo que solamente está previsto para personas. Por eso no está permitido utilizar las asas para la sujecion en o sobre medios de transporte como por ejemplo grúas, carretillas elevadoras de horquilla, carros etc. El usuario es responsable de que los productos sean sujetados de forma segura a los medios de transporte y de que las prescripciones de seguridad del fabricante de los medios de transporte sean tenidas en cuenta. En caso de que no se tengan en cuenta pueden causarse daños en personas y objetos.
32. Si llega a utilizar el producto dentro de un vehículo, queda en la responsabilidad absoluta del conductor que conducir el vehículo de manera segura. Asegure el producto dentro del vehículo debidamente para evitar en caso de un accidente las lesiones u otra clase de daños. No utilice nunca el producto dentro de un vehículo en movimiento si esto pudiera distraer al conductor. Siempre queda en la responsabilidad absoluta del conductor la seguridad del vehículo y el fabricante no asumirá ninguna clase de responsabilidad por accidentes o colisiones.
33. Dado el caso de que esté integrado un producto de laser en un producto R&S (por ejemplo CD/DVD-ROM) no utilice otras instalaciones o funciones que las descritas en la documentación. De otra manera pondrá en peligro su salud, ya que el rayo laser puede dañar irreversiblemente sus ojos. Nunca trate de descomponer estos productos. Nunca mire dentro del rayo laser.



## Certified Quality System

**DIN EN ISO 9001 : 2000**  
**DIN EN 9100 : 2003**  
**DIN EN ISO 14001 : 1996**

**DQS REG. NO 001954 QM/ST UM**

### QUALITÄTSZERTIFIKAT

*Sehr geehrter Kunde,*

Sie haben sich für den Kauf eines Rohde & Schwarz-Produktes entschieden. Hiermit erhalten Sie ein nach modernsten Fertigungsmethoden hergestelltes Produkt. Es wurde nach den Regeln unseres Managementsystems entwickelt, gefertigt und geprüft.

Das Rohde & Schwarz Managementsystem ist zertifiziert nach:

DIN EN ISO 9001:2000  
DIN EN 9100:2003  
DIN EN ISO 14001:1996

### CERTIFICATE OF QUALITY

*Dear Customer,*

you have decided to buy a Rohde & Schwarz product. You are thus assured of receiving a product that is manufactured using the most modern methods available. This product was developed, manufactured and tested in compliance with our quality management system standards.

The Rohde & Schwarz quality management system is certified according to:

DIN EN ISO 9001:2000  
DIN EN 9100:2003  
DIN EN ISO 14001:1996

### CERTIFICAT DE QUALITÉ

*Cher Client,*

vous avez choisi d'acheter un produit Rohde & Schwarz. Vous disposez donc d'un produit fabriqué d'après les méthodes les plus avancées. Le développement, la fabrication et les tests respectent nos normes de gestion qualité.

Le système de gestion qualité de Rohde & Schwarz a été homologué conformément aux normes:

DIN EN ISO 9001:2000  
DIN EN 9100:2003  
DIN EN ISO 14001:1996



**ROHDE & SCHWARZ**



Certificate No.: 2005-02

This is to certify that:

Equipment type	Stock No.	Designation
IMS	1502.0009.02/.04	Integrated Measurement System
IMS-B2	1502.0838.02	Transfer Relay
IMS-B3	1502.0873.02	Gen. Intlk. Relay
IMS-B4	1502.0915.02	Upgrade to EMC32-A+
IMS-B7	1502.0721.02	Hardware Extension Power Sensor

complies with the provisions of the Directive of the Council of the European Union on the approximation of the laws of the Member States

- relating to electrical equipment for use within defined voltage limits  
(73/23/EEC revised by 93/68/EEC)
- relating to electromagnetic compatibility  
(89/336/EEC revised by 91/263/EEC, 92/31/EEC, 93/68/EEC)

Conformity is proven by compliance with the following standards:

EN61010-1 : 2001-12  
EN55011 : 1998 + A1 : 1999, Klasse B  
EN61326 : 1997 + A1 : 1998 + A2 : 2001

For the assessment of electromagnetic compatibility, the limits of radio interference for Class B equipment as well as the immunity to interference for operation in industry have been used as a basis.

Affixing the EC conformity mark as from 2005

**ROHDE & SCHWARZ GmbH & Co. KG**  
Mühldorfstr. 15, D-81671 München

Munich, 2005-02-02

Central Quality Management MF-QZ / Radde



# Customer Support

## Technical support – where and when you need it

For quick, expert help with any Rohde & Schwarz equipment, contact one of our Customer Support Centers. A team of highly qualified engineers provides telephone support and will work with you to find a solution to your query on any aspect of the operation, programming or applications of Rohde & Schwarz equipment.

## Up-to-date information and upgrades

To keep your Rohde & Schwarz equipment always up-to-date, please subscribe to our electronic newsletter at

<http://www.rohde-schwarz.com/www/response.nsf/newsletterpreselection>

or request the desired information and upgrades via email from your Customer Support Center (addresses see below).

## Feedback

We want to know if we are meeting your support needs. If you have any comments please email us and let us know [CustomerSupport.Feedback@rohde-schwarz.com](mailto:CustomerSupport.Feedback@rohde-schwarz.com).

---

### USA & Canada

Monday to Friday (except US public holidays)

8:00 AM – 8:00 PM Eastern Standard Time (EST)

Tel. from USA 888-test-rsa (888-837-8772) (opt 2)

From outside USA +1 410 910 7800 (opt 2)

Fax +1 410 910 7801

E-mail [Customer.Support@rsa.rohde-schwarz.com](mailto:Customer.Support@rsa.rohde-schwarz.com)

### East Asia

Monday to Friday (except Singaporean public holidays)

8:30 AM – 6:00 PM Singapore Time (SGT)

Tel. +65 6 513 0488

Fax +65 6 846 1090

E-mail [Customersupport.asia@rohde-schwarz.com](mailto:Customersupport.asia@rohde-schwarz.com)

### Rest of the World

Monday to Friday (except German public holidays)

08:00 – 17:00 Central European Time (CET)

Tel. from Europe +49 (0) 180 512 42 42

From outside Europe +49 89 4129 13776

Fax +49 (0) 89 41 29 637 78

E-mail [CustomerSupport@rohde-schwarz.com](mailto:CustomerSupport@rohde-schwarz.com)



# Adressen/Addresses

## FIRMENSITZ/HEADQUARTERS

(Tel) Phone  
(Fax) Fax  
E-mail

Rohde & Schwarz GmbH & Co. KG  
Mühlendorfstraße 15 · D-81671 München  
Postfach 80 14 69 · D-81614 München

(Tel) +49 (89) 41 29-0  
(Fax) +49 89 4129-121 64  
info@rohde-schwarz.com

## WERKE/PLANTS

Rohde & Schwarz Messgerätebau GmbH  
Riedbachstraße 58 · D-87700 Memmingen  
Postfach 1652 · D-87686 Memmingen

(Tel) +49 (8331) 108-0  
(Fax) +49 (8331) 108-11 24  
info.rsdmb@rohde-schwarz.com

Rohde & Schwarz GmbH & Co. KG  
Werk Teisnach  
Kaikenrieder Straße 27 · D-94244 Teisnach  
Postfach 1149 · D-94240 Teisnach

(Tel) +49 (9923) 857-0  
(Fax) +49 (9923) 857-11 74  
info.rsdts@rohde-schwarz.com

Rohde & Schwarz GmbH & Co. KG  
Dienstleistungszentrum Köln  
Graf-Zeppelin-Straße 18 · D-51147 Köln  
Postfach 98 02 60 · D-51130 Köln

(Tel) +49 (2203) 49-0  
(Fax) +49 (2203) 49 51-229  
info.rsd@rohde-schwarz.com  
schwarz.com-service.rsd@rohde-schwarz.com

## TOCHTERUNTERNEHMEN/SUBSIDIARIES

Rohde & Schwarz Vertriebs-GmbH  
Mühlendorfstraße 15 · D-81671 München  
Postfach 80 14 69 · D-81614 München

(Tel) +49 (89) 41 29-137 74  
(Fax) +49 (89) 41 29-137 77  
customersupport@rohde-schwarz.com

Rohde & Schwarz International GmbH  
Mühlendorfstraße 15 · D-81671 München  
Postfach 80 14 60 · D-81614 München

(Tel) +49 (89) 41 29-129 84  
(Fax) +49 (89) 41 29-120 50  
info.rusis@rohde-schwarz.com

Rohde & Schwarz Engineering and Sales GmbH  
Mühlendorfstraße 15 · D-81671 München  
Postfach 80 14 29 · D-81614 München

(Tel) +49 (89) 41 29-137 11  
(Fax) +49 (89) 41 29-137 23  
info.rse@rohde-schwarz.com

R&S BICK Mobilfunk GmbH  
Fritz-Hahne-Str. 7 · D-31848 Bad Münder  
Postfach 2062 · D-31844 Bad Münder

(Tel) +49 (5042) 998-0  
(Fax) +49 (5042) 998-105  
info.rsbeck@rohde-schwarz.com

Rohde & Schwarz FTK GmbH  
Wendenschlossstraße 168, Haus 28  
D-12557 Berlin

(Tel) +49 (30) 658 91-122  
(Fax) +49 (30) 655 50-221  
info.ftk@rohde-schwarz.com

Rohde & Schwarz SIT GmbH  
Agastraße 3  
D-12489 Berlin

(Tel) +49 (30) 658 84-0  
(Fax) +49 (30) 658 84-183  
info.sit@rohde-schwarz.com

R&S Systems GmbH  
Graf-Zeppelin-Straße 18 · D-51147 Köln  
Postfach 98 02 60 · D-51130 Köln

(Tel) +49 (2203) 49-5 23 25  
(Fax) +49 (2203) 49-5 23 36  
info.rssys@rohde-schwarz.com

## ADRESSEN WELTWEIT/ADDRESSES WORLDWIDE

**Albania** siehe/see Austria

**Algeria** Rohde & Schwarz  
Bureau d'Alger  
5B Place de Laperrine  
16035 Hydra-Alger

(Tel) +213 (21) 48 20 18  
(Fax) +213 (21) 69 46 08

**Antilles (Neth.)** siehe / see Mexico

**Argentina** Precision Electronica S.R.L.  
Av. Pde Julio A. Roca 710 - 6° Piso  
1067 Buenos Aires

(Tel) +541 (14) 331 10 67  
(Fax) +541 (14) 334 51 11  
alberto.lombardi@prec-elec.com.ar

**Australia** Rohde & Schwarz (Australia) Pty. Ltd.  
Sales Support  
Unit 6  
2-8 South Street  
Rydalmere, N.S.W. 2116

(Tel) +61 (2) 88 45 41 00  
(Fax) +61 (2) 96 38 39 88  
sales@rsa.us.rohde-schwarz.com

**Austria** Rohde & Schwarz-Österreich Ges.m.b.H.  
Am Europlatz 3  
Gebäude B  
1120 Wien

(Tel) +43 (1) 602 61 41-0  
(Fax) +43 (1) 602 61 41-14  
rs-austria@rsoe.rohde-schwarz.com

**Azerbaijan** Rohde & Schwarz Azerbaijan  
Liaison Office Baku  
ISR Plaza, 5th floor  
340 Nizami Str.  
370000 Baku

(Tel) +994 (12) 93 31 38  
(Fax) +994 (12) 93 03 14  
rs-azerbaijan@rsd.rohde-schwarz.com

**Bangladesh** BIL Consortium Ltd.  
Corporate Office  
House-33, Road-4, Block-F  
Banani, Dhaka-1213

(Tel) +880 (2) 881 06 53  
(Fax) +880 (2) 882 82 91

**Barbados** siehe / see Mexico

**Belarus** siehe/see Ukraine

**Belgium** Rohde & Schwarz Belgium N.V.  
Excelsiorlaan 31 Bus 1  
1930 Zaventem

(Tel) +32 (2) 721 50 02  
(Fax) +32 (2) 725 09 36  
info@rsb.rohde-schwarz.com

**Belize** siehe / see Mexico

**Bermuda** siehe/see Mexico

**Bosnia-Herzegovina** siehe/see Slovenia

**Brazil** Rohde & Schwarz Do Brasil Ltda.  
Av. Alfredo Egidio de Souza Aranha (Rod. Araxá)  
1° andar - Santo Amaro  
04726-170 Sao Paulo - SP

(Tel) +55 (11) 56 44 86 11  
(Fax) +55 (11) 56 44 86 25 (sales)  
(Fax) +55 (11) 56 44 86 36  
sales-brazil@rsdb.rohde-schwarz.com

**Brunei** George Keen Lee Equipment Pte Ltd.  
#11-01 BP Tower  
396 Alexandra Road  
Singapore 119954

(Tel) +656 276 06 26  
(Fax) +656 276 06 29  
gkleqpt@singnet.com.sg

**Bulgaria** Rohde & Schwarz  
Representation Office Bulgaria  
39, Fridtjof Nansen Blvd.  
1000 Sofia

(Tel) +359 (2) 96 343 34  
(Fax) +359 (2) 963 21 97  
rs-bulgaria@rsbg.rohde-schwarz

**Canada** Rohde & Schwarz Canada Inc.  
555 March Rd.  
Kanata, Ontario K2K 2M5

(Tel) +1 (613) 592 80 00  
(Fax) +1 (613) 592 80 09  
sales@rscanada.ca

**Chile** Dymeq Ltda.  
Av. Larrain 6666  
Santiago

(Tel) +56 (2) 339 20 00  
(Fax) +56 (2) 339 20 10  
dymeq@dymeq.com

**China** Rohde & Schwarz China Ltd.  
Representative Office Beijing  
6F, Parkview Center  
2 Jiangtai Road  
Chao Yang District  
Beijing 100016

(Tel) +86 (10) 64 31 28 28  
(Fax) +86 (10) 64 37 98 88  
info.rschina@rsbp.rohde-schwarz.com

Rohde & Schwarz China Ltd.  
Representative Office Shanghai  
Room 807-809, Central Plaza  
227 Huangpi North Road  
Shanghai 200003

(Tel) +86 (21) 63 75 00 18  
(Fax) +86 (21) 63 75 91 70  
May.Zhu@rsbp.rohde-schwarz.com

Rohde & Schwarz China Ltd.  
Representative Office Guangzhou  
Room 2903, Metro Plaza  
183 Tian He North Road  
Guangzhou 510075

(Tel) +86 (20) 87 55 47 58  
(Fax) +86 (20) 87 55 47 59  
Winnie.Lin@rsbp.rohde-schwarz.com





# Adressen/Addresses

<b>India</b>	Rohde & Schwarz India Pvt. Ltd. Mumbai Office B-603, Remi Bizcourt, Shah Industrial Estate, Off Veera Desai Road Andheri West Mumbai - 400 058	(Tel) +91 (22) 26 30 18 10 (Fax) +91 (22) 26 73 20 81 rsindiam@rsnl.net	<b>Kazakhstan</b>	Rohde & Schwarz Kazakhstan Representative Office Almaty Pl. Respubliki 15 480013 Almaty	(Tel) +7 (32) 72 67 23 54 (Fax) +7 (32) 72 67 23 46 rs-kazakhstan@rsd-rohde-schwarz.com
<b>Indonesia</b>	PT Rohde & Schwarz Indonesia Graha Paramita 5th Floor Jln. Denpasar Raya Blok D-2 Jakarta 12940	(Tel) +62 (21) 252 36 08 (Fax) +62 (21) 252 36 07 sales@rsbj.rohde-schwarz.com-services@rsbj.rohde-schwarz.com	<b>Kenya</b>	Excel Enterprises Ltd Dunga Road P.O.Box 42 788 Nairobi	(Tel) +254 (2) 55 80 88 (Fax) +254 (2) 54 46 79
<b>Iran</b>	Rohde & Schwarz Iran Liaison Office Tehran Groundfloor No. 1, 14th Street Khaled Eslamboli (Vozara) Ave. 15117 Tehran	(Tel) +98 (21) 872 42 96 (Fax) +98 (21) 871 90 12 alfred.korff@rsd.rohde-schwarz.com	<b>Korea</b>	Rohde & Schwarz Korea Ltd. 83-29 Nonhyun-Dong, Kangnam-Ku  Seoul 135-010	(Tel) +82 (2) 34 85 19 00 (Fax) +82 (2) 547 43 00 sales@rskor.rohde-schwarz.com-service@rskor.rohde-schwarz.com
<b>Ireland</b>	siehe/see United Kingdom		<b>Kuwait</b>	Group Five Trading & Contracting Co. Mezzanine Floor Al-Bana Towers Ahmad Al Jaber Street Sharq	(Tel) +965 (244) 91 72/73/74 (Fax) +965 (244) 95 28 jk_agarwal@yahoo.com
<b>Israel</b>	Eastronics Ltd. Measurement Products 11 Rozanis St. P.O.Box 39300 Tel Aviv 61392	(Tel) +972 (3) 645 87 77 (Fax) +972 (3) 645 86 66 david_hasky@easx.co.il	<b>Latvia</b>	Rohde & Schwarz Danmark A/S Latvian Branch Office Merkela iela 21-301 1050 Riga	(Tel) +371 (7) 50 23 55 (Fax) +371 (7) 50 23 60 latvia@rsdk.rohde-schwarz.com
	J.M. Moss (Engineering) Ltd. Communications Products 9 Oded Street P.O.Box 967 52109 Ramat Gan	(Tel) +972 (3) 631 20 57 (Fax) +972 (3) 631 40 58 jmoss@zahav.net.il	<b>Lebanon</b>	Rohde & Schwarz Liaison Office Riyadh P.O.Box 361 Riyadh 11411	(Tel) +966 (1) 465 64 28 Ext. 303 (Fax) +966 (1) 465 64 28 Ext. 229 chris.porzky@rsd.rohde-schwarz.com
<b>Italy</b>	Rohde & Schwarz Italia S.p.a. Centro Direzionale Lombardo Via Roma 108 20060 Cassina de Pecchi (MI)	(Tel) +39 (02) 95 70 41 (Fax) +39 (02) 95 30 27 72 rsi.info@rsi.rohde-schwarz.com		Netcom P.O.Box 55199 Op. Ex-Presidential Palace Horch Tabet Beirut	(Tel) +961 (1) 48 69 99 (Fax) +961 (1) 49 05 11 tohme.sayar@netcomm.tv
	Rohde & Schwarz Italia S.p.a. Via Tiburtina 1182 00156 Roma	(Tel) +39 (06) 41 59 81 (Fax) +39 (06) 41 59 82 70 rsi.info@rsi.rohde-schwarz.com	<b>Liechtenstein</b>	siehe/see Switzerland	
<b>Jamaica</b>	siehe / see Mexico		<b>Lithuania</b>	Rohde & Schwarz Danmark A/S Lithuanian Branch Office Lukiskiu 5-228 2600 Vilnius	(Tel) +370 (5) 239 50 10 (Fax) +370 (5) 239 50 11 lithuania@rsdk.rohde-schwarz.com
<b>Japan</b>	Rohde & Schwarz Japan K.K. Tokyo Office 711 Bldg., Room 501 (5th floor) 7-11-18 Nishi-Shinjuku Shinjuku-ku Tokyo 160-0023	(Tel) +81 (3) 59 25 12 88 (Fax) +81 (3) 59 25 12 90 scj.support@rsjp.rohde-schwarz.com	<b>Luxembourg</b>	siehe/see Belgium	
	Rohde & Schwarz Japan K.K. Shin-Yokohama Office KM Daiichi Bldg., 8F 2-13-13 Kouhoku-ku Yokohama-shi Kanagawa 222-0033	(Tel) +81 (4) 54 77 35 70	<b>Macedonia</b>	NETRA Sarski odred 7 1000 Skopje	(Tel) +389 (2) 329 82 30 (Fax) +389 (2) 317 74 88 netra@netra.com.sk
	Rohde & Schwarz Japan K.K. Osaka Office TEK Dai 2 Bldg., 8F 1-13-20 Esaka-shi Suita-shi Osaka-fu 564-0063	(Tel) +81 (6) 63 10 96 51	<b>Malaysia</b>	Rohde & Schwarz Malaysia Sdn Bhd Suite 10.04, Level 10, Wisma E&C No. 2 Lorong Dungun Kiri Damansara Heights 50490 Kuala-Lumpur	(Tel) +60 (3) 20 94 00 33 (Fax) +60 (3) 20 94 24 33 sales.malaysia@rohde-schwarz.com
<b>Jordan</b>	Jordan Crown Engineering & Trading Co. Jabal Amman, Second Circle Youssef Ezzideen Street P.O.Box 830414 Amman, 11183	(Tel) +962 (6) 462 17 29 (Fax) +962 (6) 465 96 72 jocrown@go.com.jo	<b>Malta</b>	Tektraco International Technology Ltd. 121, B'Kara Road San Gwann SGN 08	(Tel) +356 (21) 37 43 00 or 37 80 88 (Fax) +356 (21) 37 66 67 sales@tektraco.com
			<b>Mexico</b>	Rohde & Schwarz de Mexico S. de R.L. de C.V. German Centre Oficina 4-2-2 Av. Santa Fé 170 Col. Lomas de Santa Fé 01210 Mexico D.F.	(Tel) +52 (55) 85 03 99 13 (Fax) +52 (55) 85 03 99 16 latinoamerica@rsd-rohde-schwarz.com
			<b>Moldava</b>	siehe/see Austria	
			<b>Nepal</b>	ICTC Pvt. Ltd. Hattisar, Post Box No. 660 Kathmandu	(Tel) +977 (1) 443 48 95 (Fax) +977 (1) 443 49 37 ictc@mos.com.np

# Adressen/Addresses

<b>Netherlands</b>	Rohde & Schwarz Nederland B.V. Perkinsbaan 1 3439 ND Nieuwegein	(Tel) +31 (30) 600 17 00 (Fax) +31 (30) 600 17 99 info@rsn.rohde-schwarz.com	<b>Saudi Arabia</b>	Gentec Haji Abdullah Alireza & Co. Ltd. P.O.Box 43054 Riyadh	(Tel) +966 (1) 293 20 35 (Fax) +966 (1) 466 16 57 akanbar@gentec.com.sa
<b>New Zealand</b>	Nichecom 1 Lincoln Ave. Tawa, Wellington	(Tel) +64 (4) 232 32 33 (Fax) +64 (4) 232 32 30 rob@nichecom.co.nz	<b>Serbia-Montenegro</b>	Rohde & Schwarz Representative Office Belgrade Tose Jovanovica 7 11030 Beograd	(Tel) +381 (11) 305 50 25 (Fax) +381 (11) 305 50 24 rs-scg@rscs.rohde-schwarz.com
<b>Nicaragua</b>	siehe/see Mexico				
<b>Nigeria</b>	Ferrostaal Abuja Plot 3323, Barada Close P.O.Box 8513, Wuse Off Amazon Street Maitama, Abuja	(Tel) +234 (9) 413 52 51 (Fax) +234 (9) 413 52 50 fsabuja@rosecom.net	<b>Singapore</b>	Rohde & Schwarz Regional Headquarters Singapore Pte. Ltd. 1 Kaki Bukit View #05-01/02 Techview Singapore 415 941	(Tel) +65 68 46 18 72 (Fax) +65 68 46 12 52
<b>Norway</b>	Rohde & Schwarz Norge AS Enebakkeveien 302 B 1188 Oslo	(Tel) +47 (23) 38 66 00 (Fax) +47 (23) 38 66 01 firmapost@rsnor.rohde-schwarz.com		Rohde & Schwarz Systems & Communications Asia Pte Ltd Service 1 Kaki Bukit View #04-01/07 Techview Singapore 415 941	(Tel) +65 68 46 37 10 (Fax) +65 68 46 00 29 info@rssg.rohde-schwarz.com
<b>Oman</b>	Mustafa Sultan Science & Industry Co.LLC. Test & Measurement Products Way No. 3503 Building No. 241 Postal Code 112 Al Khuwair, Muscat	(Tel) +968 63 60 00 (Fax) +968 60 70 66 m-aziz@mustafasultan.com	<b>Slovak Republic</b>	Specialne systémy a software, a.s. Svrčia ul. 3 841 04 Bratislava 4	(Tel) +421 (2) 65 42 24 88 (Fax) +421 (2) 65 42 07 68 3s@special.sk
<b>Pakistan</b>	Siemens Pakistan 23, West Jinnah Avenue Islamabad	(Tel) +92 (51) 227 22 00 (Fax) +92 (51) 227 54 98 reza.bokhary@siemens.com.pk	<b>Slovenia</b>	Rohde & Schwarz Representative Office Ljubljana Tbilisjska 89 1000 Ljubljana	(Tel) +386 (1) 423 46 51 (Fax) +386 (1) 423 46 11 rs-slovenia@rssi.rohde-schwarz.com
<b>Panama</b>	siehe/see Mexico				
<b>Papua New Guinea</b>	siehe/see Australia				
<b>Paraguay</b>	siehe/see Argentina				
<b>Philippines</b>	Rohde & Schwarz (Philippines) Inc. Unit 2301, PBCOM Tower 6795, Ayala Ave. cor. Herrera St. Makati City	(Tel) +63 (2) 753 14 44 (Fax) +63 (2) 753 14 56	<b>South Africa</b>	Protea Data Systems (Pty.) Ltd. Communications and Measurement Division Private Bag X19 Bramley 2018	(Tel) +27 (11) 719 57 00 (Fax) +27 (11) 786 58 91 unicm@protea.co.za
<b>Poland</b>	Rohde & Schwarz SP.z o.o. Przedstawicielstwo w Polsce ul. Stawki 2, Pietro 28 00-193 Warszawa	(Tel) +48 (22) 860 64 94 (Fax) +48 (22) 860 64 99 rs-poland@rspl.rohde-schwarz.com		Protea Data Systems (Pty.) Ltd. Cape Town Branch Unit G9, Centurion Business Park Bosmandam Road Milnerton Cape Town, 7441	(Tel) +27 (21) 555 36 32 (Fax) +27 (21) 555 42 67 unicm@protea.co.za
<b>Portugal</b>	Rohde & Schwarz Portugal, Lda. Alameda Antonio Sergio 7-R/C - Sala A 2795-023 Linda-a-Velha	(Tel) +351 (21) 415 57 00 (Fax) +351 (21) 415 57 10 info@rspt.rohde-schwarz.com	<b>Spain</b>	Rohde & Schwarz Espana S.A. Salcedo, 11 28034 Madrid	(Tel) +34 (91) 334 10 70 (Fax) +34 (91) 729 05 06 rses@rses.rohde-schwarz.com
<b>Republic Dominican</b>	siehe/see Mexico				
<b>Romania</b>	Rohde & Schwarz Representation Office Bucharest 89 Eroii Sanitari Blvd., sector 5 050472 Bucuresti	(Tel) +40 (21) 411 20 13 (Fax) +40 (21) 410 68 46 rs-romania@rsro.rohde-schwarz.com	<b>Sri Lanka</b>	Dynatel Communications (PTE) Ltd. 451/A Kandy Road Kelaniya	(Tel) +94 (112) 90 80 01 (Fax) +94 (112) 91 04 69 69 dynatel@dyanet.lk
<b>Russian Federation</b>	Rohde & Schwarz International GmbH 119180, Yakimanskaya nab., 2 Moscow	(Tel) +7 (095) 745 88 50 to 53 (Fax) +7 (095) 745 88 54 rs-russia@rsru.rohde-schwarz.com	<b>Sudan</b>	SolarMan Co. Ltd. P.O.Box 11 545 North of Fraouq Cementry 6/7/9 Bldg. 16 Karthoum	(Tel) +249 (183) 47 31 08 (Fax) +249 (183) 47 31 38 solarman29@hotmail.com
<b>Saudi Arabia</b>	Rohde & Schwarz International GmbH - Liaison Office Riyadh c/o Haji Abdullah Alireza Co. Ltd. P.O.Box 361 Riyadh 11411	(Tel) +966 (1) 293 2035 (Fax) +966 (1) 466 1657 chris.porzky@rsd.rohde-schwarz.com	<b>Sweden</b>	Rohde & Schwarz Sverige AB Flygfältsgatan 15 128 30 Skarpnäck	(Tel) +46 (8) 605 19 00 (Fax) +46 (8) 605 19 80 info@rss.rohde-schwarz.com
			<b>Switzerland</b>	Roschi Rohde & Schwarz AG Mühlestr. 7 3063 Ittigen	(Tel) +41 (31) 922 15 22 (Fax) +41 (31) 921 81 01 support@roschi.rohde-schwarz.com
			<b>Syria</b>	Electro Scientific Office Baghdad Street Dawara Clinical Lab. Bldg P.O.Box 8162 Damascus	(Tel) +963 (11) 231 59 74 (Fax) +963 (11) 231 88 75 memo@hamshointl.com

# Adressen/Addresses

<b>Taiwan</b>	Rohde & Schwarz Taiwan (Pvt.) Ltd. Floor 14, No. 13, Sec. 2, Pei-Tou Road Taipei 112	(Tel) +886 (2) 28 93 10 88 (Fax) +886 (2) 28 91 72 60 celine.tu@rstw.rohde-schwarz.com	<b>United Kingdom</b>	Rohde & Schwarz UK Ltd. 3000 Manchester Business Park Aviator Way Manchester M22 5TG	(Tel) +44 (870) 735 16 42 (Fax) +44 (1252) 81 14 77 sales@rsuk.rohde-schwarz.com
<b>Tanzania</b>	SSTL Group P.O. Box 7512 Dunga Street Plot 343/345 Dar Es Salaam	(Tel) +255 (22) 276 00 37 (Fax) +255 (22) 276 02 93 sstl@ud.co.tz	<b>Uruguay</b>	Aeromarine S.A. Cerro Largo 1497 11200 Montevideo	(Tel) +598 (2) 400 39 62 (Fax) +598 (2) 401 85 97 cs@aeromarine.com.uy
<b>Thailand</b>	Rohde & Schwarz International Thailand 2nd floor Gems Tower Bangrak, Suriyawong Bangkok 10600	(Tel) +66 (2) 200 07 29 (Fax) +66 (2) 267 00 79	<b>USA</b>	Rohde & Schwarz, Inc. Eastern Regional Office (US Headquarters) 8661A Robert Fulton Drive Columbia, MD 21046-2265	(Tel) +1 (410) 910 78 00 (Fax) +1 (410) 910 78 01 info@rsa.rohde-schwarz.com
	Schmidt Electronics (Thailand) Ltd. Messtechnik 202 Le Concorede Tower, 23rd Fl. Ratchadaphisek Rd. Huay kwang Bangkok 10320	(Tel) +66 (2) 69 41 47 05 (Fax) +66 (2) 69 41 47 06 salestm@schmidtelectronics.com		Rohde & Schwarz, Inc. Central Regional Office / Systems & EMI Products 8080 Tristar Drive Suite 120 Irving, TX 75063	(Tel) +1 (469) 713 53 00 (Fax) +1 (469) 713 53 01 info@rsa.rohde-schwarz.com
	TPP Operation Co. Ltd. Kommunikationstechnik 41/5 Mooban Tarinee Boromrajchonnee Road Talingchan Bangkok 10170	(Tel) +66 (2) 880 93 47 (Fax) +66 (2) 880 93 47		Rohde & Schwarz, Inc. R&D and Application Support 8905 SW Nimbus Ave Suite 240 Beaverton, OR 97008	(Tel) +1 (503) 403 47 00 (Fax) +1 (503) 403 47 01 info@rsa.rohde-schwarz.com
<b>Trinidad &amp; Tobago</b>	siehe/see Mexico	(Tel) (Fax)		Rohde & Schwarz, Inc. Western Regional Office 7700 Irvine Center Drive Suite 100 Irvine, CA 92618	(Tel) +1 (949) 885 70 00 (Fax) +1 (949) 885 70 01 info@rsa.rohde-schwarz.com
<b>Tunisia</b>	Teletek 71, Rue Alain Savary Residence Alain Savary (C64) Cit� el Khadra 1003 Tunis	(Tel) +216 (71) 77 33 88 (Fax) +216 (71) 77 05 53 teletek@gnet.tn		Rohde & Schwarz, Inc. Service & Calibration Center 8661A Robert Fulton Drive Columbia, MD 21046-2265	(Tel) +1 (410) 910 50 02 (Fax) +1 (410) 910 79 31 service.rsa@rsa.rohde-schwarz.com
<b>Turkey</b>	Rohde & Schwarz International GmbH Liaison Office Istanbul Bagdat Cad. 191/3, Arda Apt. B-Blok 81030 Selamicesme-Istanbul	(Tel) +90 (216) 385 19 17 (Fax) +90 (216) 385 19 18 nadir.guerelman@rsd.rohde-schwarz.com	<b>Vietnam</b>	Rohde & Schwarz Representative Office Vietnam Unit 807, 8/F, Schmidt Tower 239 Xuan Thuy Road Cau Giay District Hanoi	(Tel) +84 (4) 834 20 46
<b>Ukraine</b>	Rohde & Schwarz Representative Office Kiev 4, Patris Loumoumba ul. 01042 Kiev	(Tel) +38 (044) 268 60 55 (Fax) +38 (044) 268 83 64 rsbkiev@public.ua.net	<b>West Indies</b>	siehe/see Mexico	
<b>United Arab Emirates</b>	Rohde & Schwarz International GmbH Liaison Office Middle East Vertrieb P.O. Box 31156 Abu Dhabi	(Tel) +971 (2) 6335 670 (Fax) +971 (2) 6335 671 Dario Barisoni@rsd.rohde-schwarz.com			
	Rohde & Schwarz Bick Mobile Communication P.O.Box 17466 JAFZ, PPU ZG-07 Dubai	(Tel) +971 (4) 883 71 35 (Fax) +971 (4) 883 71 36			
	Rohde & Schwarz Emirates L.L.C. ESNAAD Premisses at Mussafah, P.O.Box 31156 Abu Dhabi	(Tel) +971 (2) 55 49 411 (Fax) +971 (2) 55 49 433 rsuaeam@emirates.net.ae			
<b>United Kingdom</b>	Rohde & Schwarz UK Ltd. Ancells Business Park Fleet Hampshire GU51 2UZ	(Tel) +44 (1252) 81 88 88 (sales)+44 (1252) 81 88 18 (service) (Fax) +44 (1252) 81 14 47 sales@rsuk.rohde-schwarz.com			



# Contents of the Manual

## Operating Manual

### Introduction

This operating manual provides information about:

- Technical characteristics of the instrument
- Putting into operation
- Basic operating procedures and control elements
- Operating via the remote control

The operating manual is divided into the following chapters:

First the data sheet in the General part gives an overview of the technical parameters of the R&S IMS. Chapter 1 then contains instructions on putting the system into operation with descriptions on

the controls, displays and connectors on the front and rear panels, putting the R&S IMS and the connectors to external instruments into operation, installing the operating system, loading drivers and configuring the R&S EMC32.

Chapter 2 gives an overview of manual operation.

Chapter 3 gives a description of the R&S IMS functions.

Chapter 4 contains an overview of some possible examples of R&S IMS applications, listed according to various standards.

Chapter 5 describes the use of the R&S IMS for measuring immunity to electromagnetic interference according to different EMC standards.

Chapter 6 contains an interface description for the R&S IMS together with notes on maintenance and error messages.

Chapter 7 contains the relevant parts of the description of the integrated amplifier. It only applies to R&S IMS variant 04.



# Specifications

## Generator

### RF frequency

Frequency range		9 kHz to 3 GHz
Resolution		0.1 Hz
Level setting time	at an offset of $< 1 \times 10^{-7}$	$< 10$ ms
Reference frequency		10 MHz
Aging		$2 \times 10^{-6}$ /year
Temperature drift	5 °C to 40 °C	$1 \times 10^{-6}$

### Spectral purity

Spurious		
Harmonics	level $\leq 0$ dBm, $f_c > 1$ MHz	$< -30$ dBc
Subharmonics	$f_c > 1$ MHz	$< -50$ dBc
Nonharmonics	$> 10$ kHz offset from carrier	$< -50$ dBc
Wideband noise	$f_c = 1$ GHz, carrier offset $> 2$ MHz	$< -123$ dBc
SSB phase noise	$f_c = 1$ GHz, carrier offset 20 kHz	$< -95$ dBc (1 Hz)
Residual FM	$f_c = 1$ GHz 0.3 kHz to 3 kHz  0.03 kHz to 20 kHz	$< 10$ Hz, rms $< 30$ Hz, peak $< 60$ Hz, rms $< 300$ Hz, peak
Residual AM	$f_c = 1$ GHz 0.3 kHz to 3 kHz	$< 0.03\%$ , rms $< 0.2\%$ , peak

### RF level

Level range		$-127$ dBm to $+13$ dBm
Level setting time	$< 0.3$ dB from final value	$< 200$ ms
Resolution		0.1 dB
Level uncertainty	$f_c > 100$ kHz, level $> -120$ dBm 20 °C to 30 °C	$< 1$ dB

### LF generator

Frequency range		20 Hz to 20 kHz
Frequency resolution		0.1 Hz
Frequency response	20 Hz to 20 kHz	$< 0.2$ dB
Total harmonic distortion	20 Hz to 20 kHz	$< 0.1\%$

### Modulation

<b>Amplitude modulation</b>		
Operating modes		internal, external AC/DC
Modulation depth	The modulation depth that can be set while adhering to the AM specifications decreases continuously from $+7$ dBm to $+13$ dBm	0% to 100%
Resolution		0.1%
Setting uncertainty	$f_{LF} = 1$ kHz, $m < 80\%$ , level = 0 dBm	$< 5\%$ of setting + 0.2%
AM total harmonic distortion	$f_{LF} = 1$ kHz, $m < 80\%$ , level = 0 dBm	$< 2\%$
Modulation frequency range		DC/20 Hz to 20 kHz

<b>Frequency modulation</b>		
Operating modes		internal, external AC/DC
Frequency deviation		20 Hz to 100 kHz
Resolution		<1%, min. 1 Hz
Setting uncertainty	$f_{LF} = 1 \text{ kHz}$	<5% of setting + 300 Hz
FM total harmonic distortion	$f_{LF} = 1 \text{ kHz}$ , deviation = 50 kHz	<1%
Carrier frequency deviation	external modulation on	<200 Hz
Modulation frequency range		DC/20 Hz to 80 kHz
<b>Phase modulation</b>		
Operating modes		internal
Phase deviation	$f_{LF} \leq 10 \text{ kHz}$ $10 \text{ kHz} < f_{LF} \leq 20 \text{ kHz}$	0 rad to 10 rad 0 rad to 5 rad
Resolution		<1%, min. 0.001 rad
Setting uncertainty	$f_{LF} = 1 \text{ kHz}$	<5% of setting + 0.2 rad
$\phi$ M total harmonic distortion	$f_{LF} = 1 \text{ kHz}$ , deviation = 5 rad	<1.5%
Modulation frequency range		300 Hz to 20 kHz
<b>Pulse modulation</b>		
Operating modes		internal, external AC/DC
Rise/fall time (10%/90%)		<3 $\mu$ s
Delay time (external)		<1%, min. 1 Hz
Pulse width (internal, external)		100 $\mu$ s to 1 s
Pulse period (internal)		200 $\mu$ s to 2 s
Time resolution		1 $\mu$ s

### Inputs to generator

<b>RF frequency input</b>		
Connector		BNC, female
Reference frequency		10 MHz, 5 MHz, 2 MHz
Input voltage		0.5 V to 2 V into 50 $\Omega$
<b>AM/FM modulator input</b>		
Connector		BNC, female
Input voltage for max. modulation depth or deviation		1 V
Input impedance		>100 k $\Omega$
<b>Pulse modulator input</b>		
Connector		BNC, female
Input voltage		TTL voltage

### Outputs from generator

<b>RF output</b>		
Connector		N, female
Characteristic impedance		50 $\Omega$
VSWR	$1 \text{ MHz} < f_c > 2.5 \text{ GHz}$ $2.5 \text{ GHz} < f_c > 3 \text{ GHz}$	<1.6 <1.8
Max. input level	1 minute	+36 dBm
Max. DC voltage		30 V
Attenuation to X1 through X3 (RF OUT 1 – RF OUT 3/IMS)		typ. 1.2 dB, max. 2.5 dB
<b>LF output</b>		



Connector		BNC, female
Output level		1 mV to 2 V, rms
Resolution of output voltage		<1%, 1 mV min. resolution
Interference output		<-60 dBc
<b>Reference frequency output</b>		
Connector		BNC, female
Reference frequency		10 MHz
Output voltage		>0.5 V into 50 $\Omega$

## Integrated power amplifier (model 04)

### General transmission data

Frequency range		9 kHz to 250 MHz
Input impedance		50 $\Omega$
Output impedance		50 $\Omega$ (nominal)
Input VSWR		typ. <2:2
Load VSWR	for $P_n - 0.5$ dB	max. 2:1 $\infty$ without damage
Nominal output level		>+44 dBm (25 W)
Max. input level	at nominal output level	<0 dBm, typ. -1.5 dBm
2nd order harmonics	at nominal output level	<-20 dBc, typ. -26 dBc
3rd order harmonics	at nominal output level	<-20 dBc, typ. -20 dBc
Spurious	at nominal output level	<-50 dBc
Noise level	measured with power meter	typ. -18 dBm
Decoupling factor of internal directional coupler	forward path and reverse path	>-41.5 dB, <-38.5 dB

### Interfaces

<b>RF connectors</b>		
RF IN1, FWD1, REV1		SMA, female
AMP OUT 1		N, female
<b>USB device (USB IN/AMP)</b>		
Connector		B, female
Protocol		version 2.0
<b>REMOTE CONTROL / INTERLOCK CONTROL</b>		
Connector		15-pin D-Sub, female

### Path switching

<b>Attenuation for power measurement paths</b>	9 kHz to 3 GHz	typ./max. (dB) at 3 GHz
Without option R&S IMS-B7	X4 through X10 to X11 (FWD)	3.1/4.0
With option R&S IMS-B7	X5, X7, X9, X10 to X12 (REV)	3.1/4.0
<b>Max. RF level for power measurement paths</b>		
	9 kHz to 3 GHz	
	max. level specified by pin diode switch	max. +20 dBm
<b>RF path via transfer relay with cable</b>		
	9 kHz to 3 GHz	option R&S IMS-B2 (K5)

R&S IMS model 04	AMP RF OUT to AMP OUT 1	0.9/1.2
	AMP RF OUT to AMP OUT 2	0.9/1.2
<b>RF path via transfer relay without cable</b>	9 kHz to 3 GHz	option R&S IMS-B2 (K5)
R&S IMS model 02	relay 1 to relay 2 relay 1 to relay 3	0.2/0.4 0.2/0.4
Max. poss. RF power of relay	600 W at 1 GHz	360 W at 3 GHz

## Analyzer (option R&S IMS-B1)

### Frequency

Frequency range		9 kHz to 3 GHz
Reference frequency		
Aging		$2 \times 10^{-6}/\text{year}$
Temperature drift	+5 °C to +30 °C	$1 \times 10^{-6}$
Frequency counter resolution		1 Hz, 10 Hz, 100 Hz, 1 kHz
Frequency span		1 kHz to 3 GHz, 0 Hz
<b>Spectral purity</b>		
SSB phase noise	10 kHz carrier offset	<-90 dBc (1 Hz)
Residual FM	1 kHz resolution bandwidth 1 kHz video bandwidth	<100 Hz, typ. 60 Hz
<b>Sweep time</b>		
SPAN ≥ 1 kHz		100 ms to 1000 s
SPAN ≥ 0 Hz		10 μs to 20 s
<b>Bandwidths</b>		
Resolution bandwidths (-3 dB)	in steps of 1, 2, 3, 5	200 Hz to 1 MHz
Video bandwidth	in steps of 1, 2, 3, 5	10 Hz to 1 MHz

### Amplitude

Level measurement range		>137 dB
Max. input level		
50 MHz to 3 GHz		+33 dBm
10 MHz to 50 MHz		+26 dBm
9 kHz to 10 MHz		+20 dBm
Intermodulation-free range		
1 MHz to 100 MHz	two-tone signal with 2 x -30 dBm, 0 dB input attenuation	≤-60 dBc
100 MHz to 3 GHz		≤-70 dBc
Harmonics	-40 dBm, 0 dB input attenuation	≤-60 dBc
Inherent spurious	terminated input, 0 dB input attenuation	≤-85 dBm
Other interfering signals	10 MHz to 3 GHz, -30 dBm level at first mixer	≤-60 dBc
Displayed average noise level	300 Hz resolution bandwidth, 10 Hz video bandwidth, 0 dB input attenuation	≤-110 dBm, typ. -120 dBm
1 dB compression point of first mixer	100 kHz to 3 GHz, 0 dB input attenuation	-10 dBm
Setting range of reference level		-110 dBm to +36 dBm
Input attenuation range	in 2 dB steps, manually selectable or automatically coupled with reference level	0 dB to 70 dB
Display range		80 dB, 40 dB, 16 dB, 8 dB, linear
Display units		
Logarithmic		dBm, dBmV, dBμV
Linear		V, W
Level measurement uncertainty		<1.5 dB

## Inputs

<b>RF input</b>		
Input impedance		50 $\Omega$
VSWR	10 MHz to 3 GHz, RF attenuation $\geq$ 20 dB	<1.5
Max. input level	with 30 dB input attenuation	+33 dBm
Max. DC voltage		30 V
Connector		N, female
<b>External trigger input</b>		
Connector		BNC, female
Trigger voltage		TTL voltage
<b>Reference frequency input for analyzer (option R&amp;S IMS-B1)</b>		
Connector		BNC, female
Reference frequency		10 MHz $\pm$ 50 Hz
Input voltage		0.5 V to 2 V into 50 $\Omega$

## Further R&amp;S IMS interfaces

<b>USB device (USB IN/IMS)</b>		
Connector		B, female
Protocol		version 2.0
Command set		device-specific; remote control via supplied Windows driver
<b>USB host (USB OUT)</b>		
Connector		A, female
Protocol		version 2.0
<b>Interlock</b>		
25-pin D-Sub, female	+12 V to release the interlock	interlock bridge
	floating relay contact, max. 100 V, max. 0.5 A	test-in-progress relay
	floating relay contact, max. 250 V, max. 1.0 A	3 x 2 relay contacts for releasing the interlock of the amplifiers
	12 V CMOS logic for controlling the LEDs on the front panel	six status inputs from the amplifiers for displaying the status of "operate" and "sum error"
		six TTL 5 V outputs
<b>Monitoring</b>		
9-pin D-Sub, female		four TTL 5 V inputs four TTL 5 V outputs

## Power supply

Input voltage range		100 V to 240 V 50 Hz to 60 Hz autoranging
Power consumption	model 02 without amplifier model 04 with amplifier	max. 110 VA max. 280 VA
Fuse	for all voltages	IEC 127 T3.15H/250

## General data

<b>Environmental conditions</b>		
Operating temperature range	meets DIN EN 60068-2-1/2	+5 °C to +40 °C
Storage temperature range		-20 °C to +70 °C
Relative humidity	meets DIN EN 60068-2-1/2 (non-condensing)	95% at +40 °C
<b>Mechanical resistance</b>		
Sinusoidal vibration	meets DIN EN 60068-2-2	5 Hz to 150 Hz, 2 g at 55 Hz 55 Hz to 150 Hz, 0.5 g constant
Random vibration	meets DIN EN 60068-2-64	10 Hz to 300 Hz, 1.2 g
Shock	meets DIN EN 60068-2-27 and MIL-STD-810	shock spectrum
Electromagnetic compatibility	meets EN 55011 class B and EN 61326	
RFI field strength		≤10 V/m
Safety class	meets DIN EN 61010-1/IEC 61010-1:2001	
Dimensions (W x H x D)		425 mm x 500 mm x 175 mm (4 HU)
<b>Weight</b>		
Model 02		approx. 13 kg
Model 04		approx. 22 kg

## System requirements:

Windows XP operating system, SP2 or Microsoft Patch KB822603 installed

Administrator rights

PC with Pentium processor (2.4 GHz) or comparable

256 Mbyte RAM (512 Mbyte RAM recommended)

200 Mbyte available hard disk space

Super VGA monitor, minimum resolution 1024 x 768 pixels, 65536 colors, higher resolution recommended

Available USB 2.0 interface

## Ordering information

Integrated Measurement System	R&S IMS	1502.0009.02
Integrated Measurement System with internal amplifier module 9 kHz to 250 MHz, 25 W	R&S IMS	1502.0009.04
<b>Options</b>		
Spectrum Analyzer Module	R&S IMS-B1	1502.0796.02
Transfer Relay	R&S IMS-B2	1502.0838.02
Generator Interlock Relay	R&S IMS-B3	1502.0873.02
Upgrade to R&S EMC32-A+ incl. GPIB interface for USB	R&S IMS-B4	1502.0915.02
Hardware Option for Using Two Power Sensors	R&S IMS-B7	1502.0721.02
Documentation of R&S IMS Calibration Values	R&S IMS-DCV	0240.2193.14
R&S IMS DKD Calibration (order only with device)	R&S IMS-DKD	1502.0038.14
<b>Accessories supplied</b>		
Power cable, USB cable type A – type B, CD with software, operating manual		
<b>Power sensors supported</b>		
Power Sensor (AVG) 9 kHz to 6 GHz; 200 pW to 200 mW, with short cable (0.4 m)	R&S NRP-Z91	1168.8004.04
USB Adapter (passive) for R&S NRP-Z sensors with short cable	R&S NRP-Z4	1146.8001.04
<b>Test receivers supported</b>		
EMI Test Receiver 9 kHz to 3 GHz	R&S ESCI	1166.5950.03
Test Receiver 9 kHz to 3 GHz	R&S ESPI3	1164.6407.03
Test Receiver 9 kHz to 7 GHz	R&S ESPI7	1164.6407.07



# 1 Putting into Operation

Chapter 1, "Putting into Operation", explains the control elements, displays and connectors of the Integrated Measurement System IMS with the aid of the front and rear views and describes how to put the instrument into operation. It describes the connection of external devices such as power sensors and amplifiers as well as how to install the operating system on the PC. Technical data concerning the interfaces can be found in chapter 6, Interface Description.

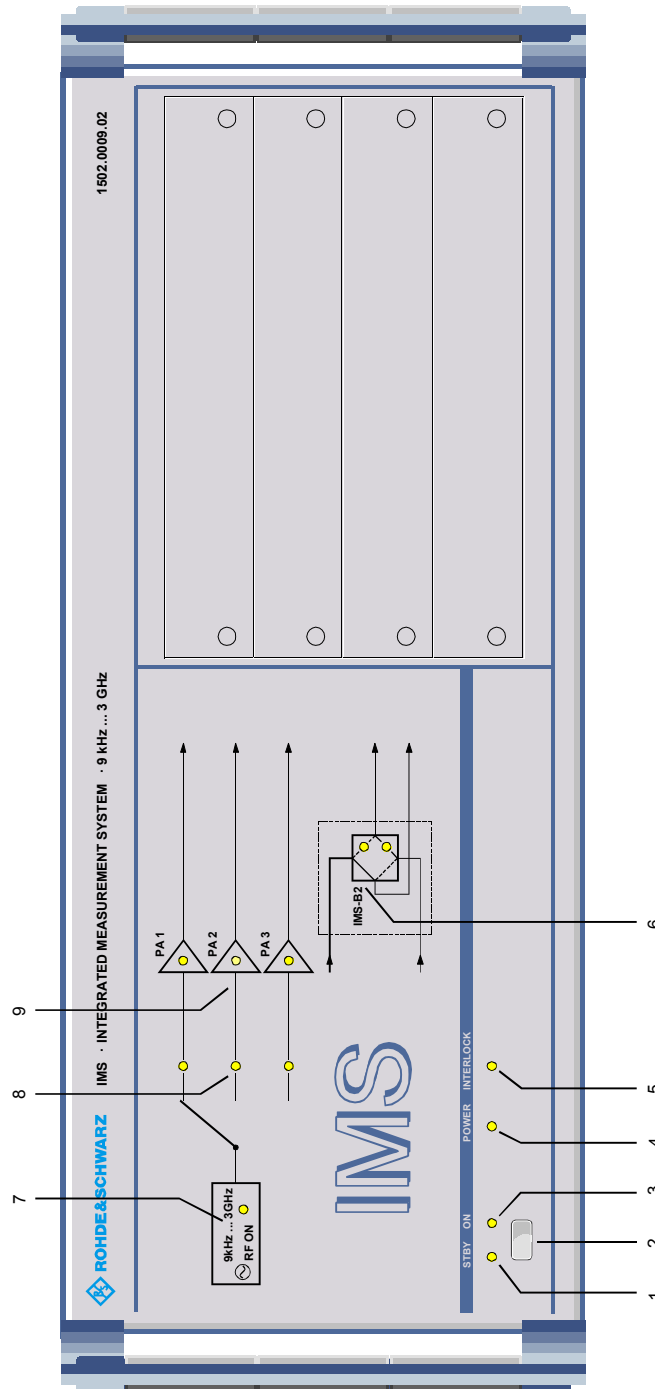
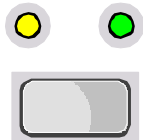

Fig. 1-1 Front view

## 1.1 Front Panel

This section gives an overview of the control elements and displays on the front panel of the R&S IMS. Each element is briefly described together with a cross-reference to the chapter or chapters where detailed information can be found.

### 1 STBY LED



The yellow LED on the left above the button shows that the instrument is in STBY mode (standby).

See chapter 1.3.5

Only power supply unit 2 is active. It powers the USB hub with +5 V and +12 V for the displays and fans.

### 2 Button

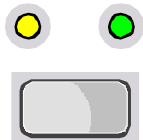

The on/off button switches the instrument from the STBY mode to the ON operating status, provided the power switch on the rear panel is switched on.

See chapter 1.3.5

The yellow LED (left) is on in the standby mode; the green LED (right) is on when the instrument is ready for operation.



**Warning!**

*The AC supply is still connected to the instrument in STBY mode.*

### 3 ON LED

The green LED on the right above the button shows that the instrument is in POWER ON mode.

The power is now on and all modules are fully operational.

### 4 POWER LED

When this two-color LED (green, red) is green, it means that all operating voltages are at their correct value. When it shows red it indicates that one or more operating voltages are out of tolerance.

### 5 INTERLOCK LED

When this two-color LED (green, red) is green, it means that the interlock is closed and the R&S IMS is ready for operation. When it shows red it indicates that the door to the test room is open and it is not possible to start a test at this time.



**6 Transfer Relay Option R&S IMS-B2**

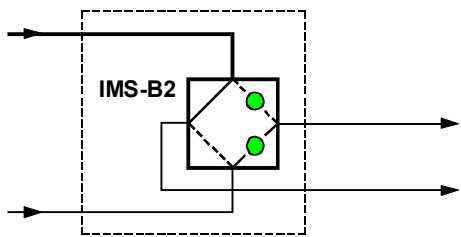

Provides the option to switch RF from one or two amplifier outputs on two RF paths.

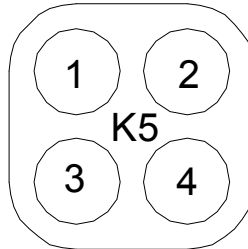

View of the N connectors of the relay



**Caution**

Do not overload the RF connections. The maximum permitted RF loading on the relay is 360 W at 3 GHz.

**Upper LED lights up**

The relay is at rest (NC) and connections are as follows:

RF output  
1 to 2, 3 to 4

**Lower LED lights up**

The relay is on (NC) and connections are as follows:

RF output  
1 to 3, 2 to 4

The appropriate R&S IMS OS device driver for switching this relay can be found in the equipment list under the name "Switch Unit" and is the IMS RSU type. Double-click on the entry to open a dialog box. The "Test" selection box contains switch commands which are listed when you click on the "Switch" button.

The command for switching the RF output 1 to 2, 3 to 4 (upper LED) is "K5\_1"

The command for switching the RF output 1 to 3, 2 to 4 (lower LED) is "K5\_2"

**7 RF ON LED in the Generator Icon**

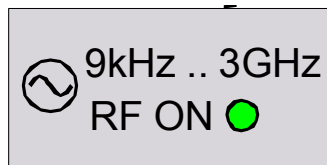

The green LED indicates that the generator module is in RF ON status.

**8 Signal Path LED**

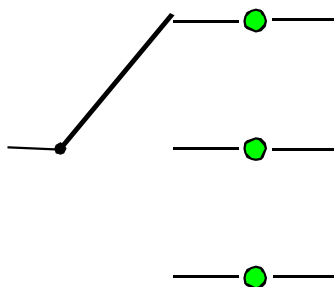

The green LEDs indicate the RF path selected for the generator signal to the amplifiers PA1, PA2, PA3 respectively.

At the same time the appropriate FWD and REV directional coupler signal is switched to the power sensor(s).

The appropriate R&S IMS OS device driver for switching these relays can be found in the equipment list under the name "Switch Unit" and is the IMS RSU type. Double-click on the entry to open a dialog box. The "Test" selection box contains switch commands which are listed when you click on the "Switch" button.

The command for switching the upper path is "PA 1" (upper LED)

The command for switching the middle path is "PA 2" (middle LED)

The command for switching the lower path is "PA 3" (lower LED)

By these commands the three relays K1, K2 and K3 are switched together to the appropriate connectors (X1, X4, X5), (X2, X6, X7) and (X3, X8, X9) resp.

9 PA x LED

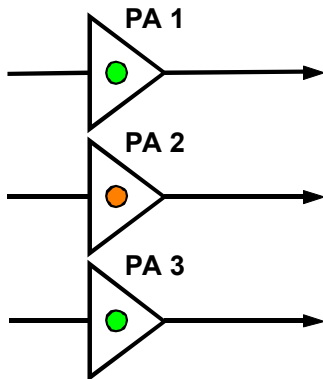

When these two-color LEDs (green, red) show green, they indicate that amplifier PA1, PA2, PA3 respectively is in "OPERATE" status.

Red LEDs indicate a "GENERAL FAULT" status in amplifier PA1, PA2, PA3 respectively, also indicating interference due to the open INTERLOCK on the amplifier.

The LED PAx displays described above are provided only by amplifiers from the Bonn company with the standard configuration for the I/O USB board in the R&S IMS. In the case of amplifiers from other manufacturers it is possible that a software-driven "Operate (PowerON) Display" may be generated in the amplifier due to changing the jumper positions on the I/O USB board.

The I/O USB board is located at the rear and to the left in the instrument when viewed from the front. To remove this board proceed as follows:

Undo the four feet on the R&S IMS and remove the cover from the instrument. Undo four fastening screws and pull the I/O USB board half out of the instrument (paying careful attention to the cable connections).

The jumpers can then be repositioned according to the following table (see component location plan for I/O USB board):

Display	Bonn amp.	Other amp.
Status PA1 Fault	X20 1-2	X20 2-3
Status PA1 RF ON	X21 1-2	X21 2-3
Status PA2 Fault	X22 1-2	X22 2-3
Status PA2 RF ON	X23 1-2	X23 2-3
Status PA3 Fault	X24 1-2	X24 2-3
Status PA3 RF ON	X25 1-2	X25 2-3

Table 1-1 Jumper assignment on the I/O board

The rest of the jumpers (X26 through X31) should not be moved, since their functionality is not under consideration at this time.

Reassemble the board in the reverse order.

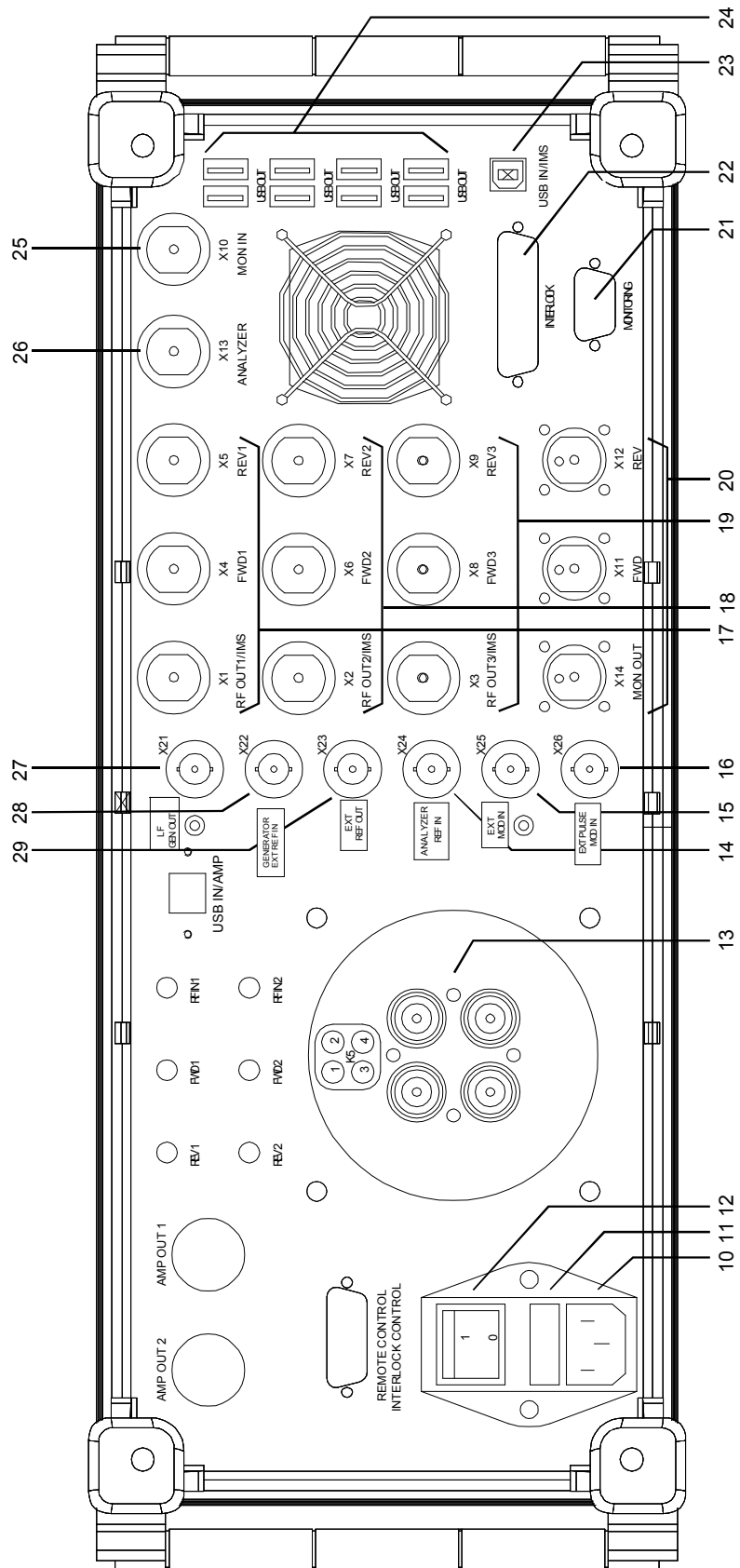

Fig. 1-2 Rear view of model 02 with option R&S IMS-B2

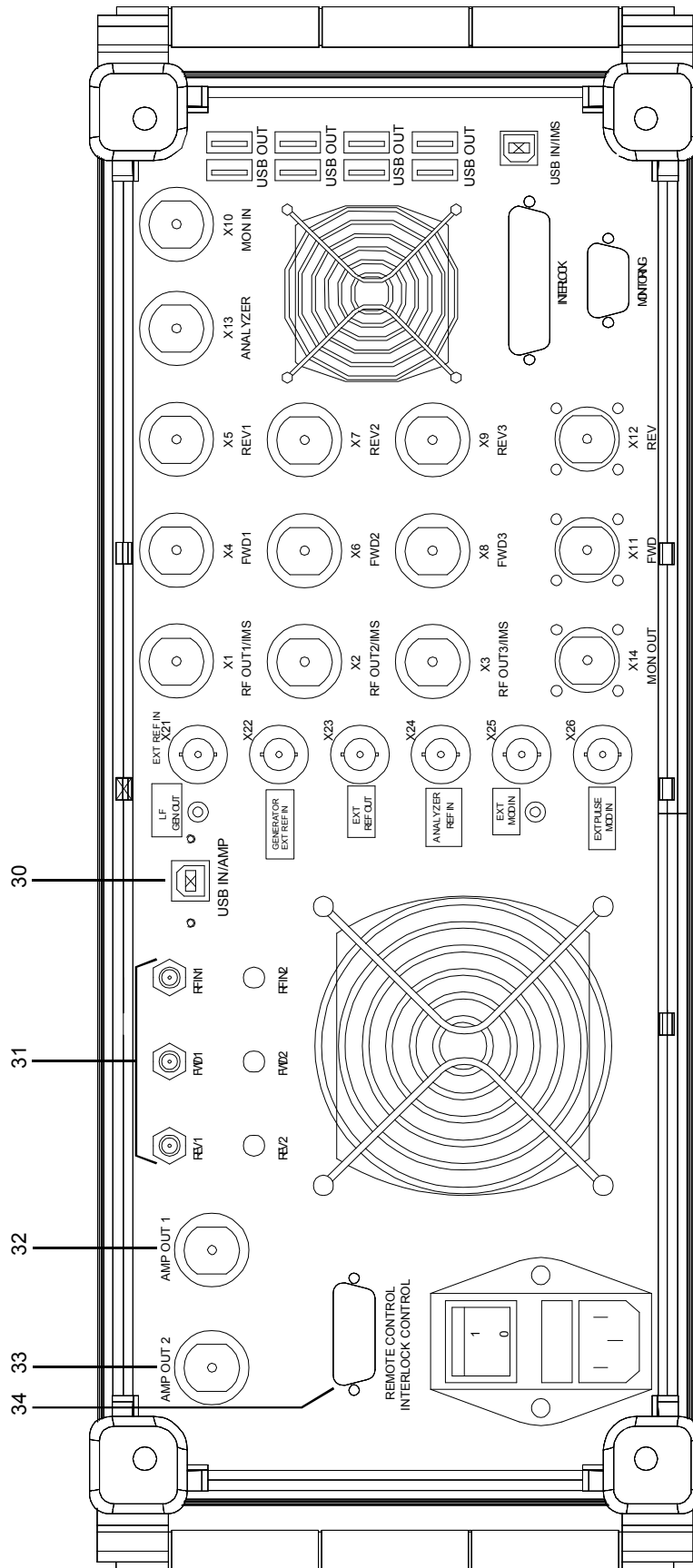
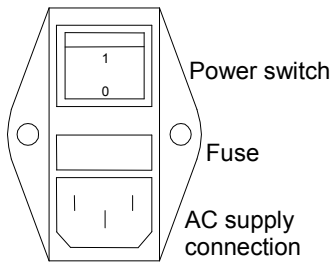

Fig. 1-3 Rear view of model 04

## 1.2 Rear Panel

This section gives an overview of the connectors on the rear panel of the R&S IMS. Each connector is briefly described and a reference is given to the chapters containing detailed information. For technical data of the connectors refer to the data sheet.

### 10, 11, 12 AC Supply



#### AC supply connector

When the R&S IMS is connected to the AC supply, it automatically sets itself to the correct range for the applied voltage (range: 100V – 230V). There is no need to set the voltage manually or change fuses.

#### Fuse

The fuse value can be read from the type label. The identifying code of the fuse is F3,15T-H

#### Power switch

A double-pole power switch is used to disconnect the R&S IMS from the AC supply.

See data sheet

### 13 Transfer Relay Option R&S IMS-B2

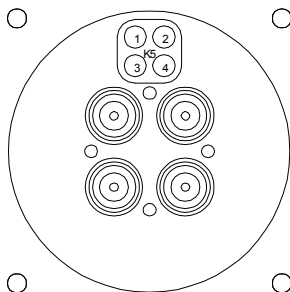

#### Transfer relay

A relay on the rear panel of model 02 or integrated into model 04 switches the RF output from one or two amplifiers on two different paths to the test sets.

In the case of an integrated amplifier the RF output of the amplifier is connected to connector 1 of the transfer relay. Connectors 2 and 3 connect outputs AMP OUT 1 and AMP OUT 2

See data sheet or element description 6 of the front panel

The appropriate R&S IMS OS device driver for switching this relay can be found in the equipment list under the name "Switch Unit" and is the IMS RSU type. Double-click on the entry to open a dialog box. The "Test" selection box contains switch commands which are listed when you click on the "Switch" button.

The command for switching the RF paths 1 to 2, 3 to 4 (upper LED) is "K5\_1"

The command for switching the RF paths 1 to 3, 2 to 4 (lower LED) is "K5\_2"

**14 Reference Signal Input for Analyzer**

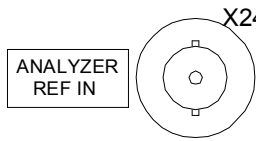

X24 ANALYZER REF IN X24

Input for external reference signal 10 MHz

See data sheet

**15 Input for External Modulation Signal - AM / FM**

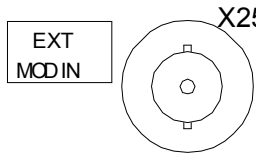

X25 EXT. MODULATION IN X25

Input for external analog modulation signals (amplitude modulation and pulse modulation).

See data sheet

**16 Input for External Modulation Signal - Pulse**

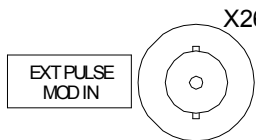

X26 EXT. PULSE MOD IN X26

Input for external pulse modulation signals.

See data sheet

**17 RF I/O for Amplifier 1**

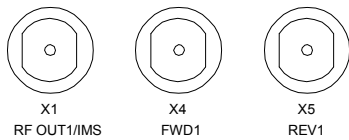

RF OUT 1/IMS X1  
FWD1 X4  
REV1 X5

Generator signal to amp. 1, directional coupler output FWD and REV from amp. 1 to the power sensor.

See data sheet

**18 RF I/O for Amplifier 2**

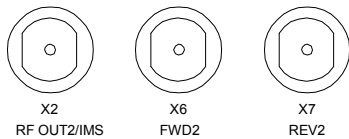

RF OUT 2/IMS X2  
FWD2 X6  
REV2 X7

Generator signal to amp. 2, directional coupler output FWD and REV from amp. 2 to the power sensor.

See data sheet

**19 RF I/O for Amplifier 3**

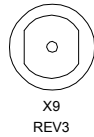
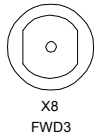
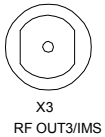

RF OUT 3/IMS X3  
FWD3 X8  
REV3 X9

Generator signal to amp. 3, directional coupler output FWD and REV from amp. 3 to the power sensor.

See data sheet

**20 Outputs for Power Sensor R&S NRP-Z91**

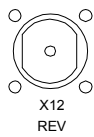
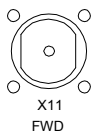
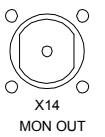

MON OUT X14  
FWD X11  
REV X12

The standard connector is **one** sensor on X11 (REV and MON IN are polled via pin switches). With option R&S IMS-B7 (two sensors) only FWD is applied to X11, whilst REV and MON OUT are on X12. Socket X14 is not used for the time being.

See data sheet



**Warning!**

*Check maximum input power and use attenuator if necessary.*

**21 MONITORING**



MONITORING

MONITORING interface 9 pin D-SUB I/O to the communication with the EUT, level TTL +5 V. Pin assignment described in chapter 6.

See chapter 6 for interface description

**22 INTERLOCK**



INTERLOCK

INTERLOCK interface 25 pin D-SUB Control contact to interlock switch. Relay contact for test lamp. Status input from amplifiers. Interlock contact to amplifier. Pin assignment described chapter 6.

See chapter 6 for interface description

**23 USB Connector - Type B**

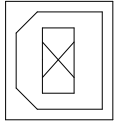

USB IN/IMS

USB (universal serial bus) interface of type B (device USB).  
Remote control input of the R&S IMS.

See data sheet

**24 USB Connectors - Type A**



USB OUT



USB OUT



USB OUT



USB OUT

USB (universal serial bus) interfaces of type A (host USB).

See data sheet

- Connection of peripherals such as amplifiers and power sensor.
- Connection of the iKey for option R&S IMS-B4, upgrade to R&S EMC32-A+ incl. GPIB interface for USB.

**25 MON IN**

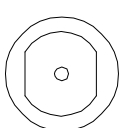

X10

MON IN

MON IN X10  
Input of a monitor signal, e.g. from a test clamp.

See data sheet



**Warning!**

Check maximum input power and use attenuator if necessary.

**26 ANALYZER**

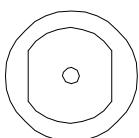

X13

ANALYZER

ANALYZER IN X13  
Input connector of the optional Analyzer module

See data sheet



**27 LF Output**

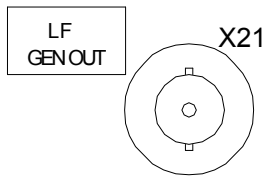

**X21 LF GEN OUT X21**  
 LF output signal from the internal LF generator in the RF generator

See data sheet

**28 Reference Signal Input for Generator**

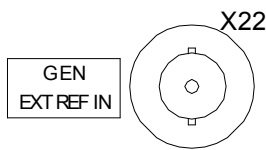

**X22 GEN EXT.REF IN X22**  
 Input for external reference signal 10 MHz

See data sheet

**29 Reference Signal Output from Generator**

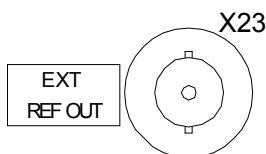

**X23 EXT. REF OUT X23**  
 Output of the internal reference signal from the generator

See data sheet

**30 USB Connector - Type B**



USB (universal serial bus) interface of type B (device USB). Remote control of the amplifier in the R&S IMS.

See data sheet

**31 RF I/O from Amplifier 1**



**RF IN1 FWD1 REV1**  
 Generator signal input for amp.1 in Model 04  
 Directional coupler output FWD and REV from amp. 1

See chapter 6 and data sheet

**32 AMP OUT 1**

AMP OUT 1

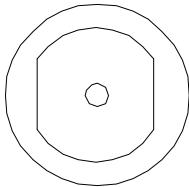

AMP OUT 1

Output from the internal amplifier in model 04.  
Standard RF output without option R&S IMS-B2.

With option R&S IMS-B2, RF output 1 is connected to connector 2 of the transfer relay.

See chapter 6 and data sheet

AMP OUT 1 is connected directly to the RF output of the internal amplifier.

With option R&S IMS-B2 AMP OUT 1 is connected to the RF output of the amplifier when the upper LED on the front panel is lit in the R&S IMS-B2 icon.

**33 AMP OUT 2**

AMP OUT 2

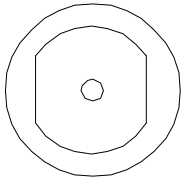

AMP OUT 2

Output from the internal amplifier in model 04.

Only in combination with option R&S IMS-B2; RF output 2 is then connected to connector 3 of the transfer relay.

See chapter 6 and data sheet

With option R&S IMS-B2 AMP OUT 2 is connected to the RF output of the amplifier when the lower LED on the front panel is lit in the R&S IMS-B2 icon.

The appropriate R&S IMS OS device driver for switching this relay can be found in the equipment list under the name "Switch Unit" and is the IMS RSU type. Double-click on the entry to open a dialog box. The "Test" selection box contains switch commands which are listed when you click on the "Switch" button.

The command for switching the amplifier output to AMP OUT 1 (upper LED) is "K5\_1"

The command for switching the amplifier output to AMP OUT 2 (lower LED) is "K5\_2"

**34 REMOTE CONTROL / INTERLOCK CONTROL**

REMOTE CONTROL 15 pin D-SUB  
Parallel I/O for data signals and status messages together with interlock control.  
The pin assignment is described in chapter 6.

See chapter 6 for interface description

## 1.3 Putting into Operation

The following section describes the procedure for putting the instrument into operation and the connection of peripherals such as amplifiers and power sensors. It contains general safety instructions for operating the instrument.

This chapter also describes how to install software updates.

The next section describes how to install the R&S IMS operating system. **The R&S IMS operating system is based on the R&S EMC32 software platform. The iKey dongle required for operating the software needs to be plugged into a USB port on the instrument.**

### 1.3.1 Unpacking the R&S IMS

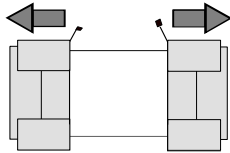

Remove protective covers

- Remove the R&S FS300 from its packaging and check that the delivery is complete using the delivery note and the accessory lists for the various items.
- Remove the two protective covers from the front and rear panel of the Integrated Measurement System and carefully check the instrument for damage.
- If there is damage, immediately contact the carrier who delivered the instrument. In this case, make sure not to discard the box and packing material.
- The original packaging is also useful for transporting or dispatching the Integrated Measurement System later on. Keep at least the two protective covers to prevent control elements and connectors from being damaged.

### 1.3.2 Setting up the Instrument or Installing it in a 19" Rack

The instrument is designed for indoor use. It can either be set up independently or mounted in a 19" rack.

A rack adapter (see data sheet for Order No.) is required for installation in a 19" rack. The mounting instructions are supplied with the adapters.

### 1.3.3 Safety Instructions



#### Caution

##### Caution

Before putting the instrument into operation, make sure that:

- The covers of the housing are in place and screwed on
- Vents are not obstructed. Make sure that the air can escape freely through the vents at the rear and at the sides. The minimum distance to the wall should therefore be at least 10 cm.
- No signal voltage levels above the permissible limits are applied to the inputs
- The outputs of the instrument are not overloaded or wrongly connected
- The instrument should only be operated in horizontal position on an even surface
- The ambient temperature must not exceed the range specified in the data sheet

Any non-compliance with these precautions may cause the instrument to be damaged.

#### 1.3.3.1 Safety Precautions against Electrostatic Discharge



To avoid damaging the electronic components of the EUT due to electrostatics produced by contact, the use of appropriate protective measures is recommended.

#### 1.3.3.2 Installing the Instrument



##### Warning!

The feet must be fully folded in or fully folded out. Only then can a stable position of the instrument and reliable operation be ensured. The uniform pressure on the folded-out feet must not exceed 500 N (weight of instrument and of equipment stacked on top). Stacked instruments must be secured against slipping (e.g. by locking the feet to the top of the front-panel frame).

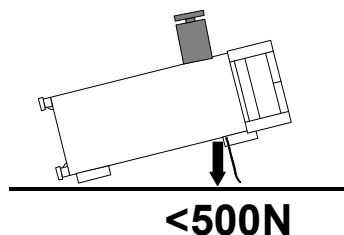

When the instrument is shifted with the feet out, the feet might fold in. To avoid injuries, do not shift the instrument when the feet are out.

#### 1.3.3.3 EMC Safety Precautions

To avoid electromagnetic interference, use only well-shielded signal cables and control cables. Any supplementary USB cables used must be type USB 2.0 with continuous shielding (like the USB cables supplied).

### 1.3.4 Connecting the R&S IMS to the AC Supply

The R&S IMS is automatically matched to the applied AC voltage (see rear panel). There is no need to set the voltage manually or change fuses. The AC supply connector is at the rear of the unit (see below).

**Note:**

**Before connecting the PC to the R&S IMS via the USB interface, it is essential to make sure that all USB drivers for the R&S IMS application have been installed.**

### 1.3.5 Switching On the R&S IMS

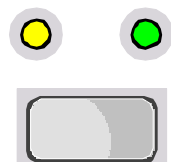
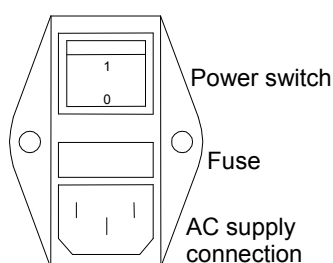

- Connect the Integrated Measurement System to the AC supply by means of the supplied power cable.

Since the instrument is in compliance with safety class EN61010-1, it should only be connected to a socket with a protective ground contact.

- Press the main power switch on the rear panel of the instrument to position I.

After power-up the instrument is either ready for operation (STBY) or in operating mode, depending on the position of the ON/STBY switch on the instrument front panel (see below).

- If the R&S IMS is on STBY after power-up, the yellow LED lights up. The USB hub and the INTERLOCK are active.

---

**Note:** *All USB devices can be addressed from the PC during STBY mode except the generator, the option R&S IMS-B1 analyzer and the switch unit.*

---

- Press the ON/STBY switch on the front panel; the green LED must be light up.

The instrument is ready for operation. All modules in the instrument are supplied with power.

---

**Note:** *A dialog with the instruments is only possible when the interlock is closed. Contacts 1 and 3 of the 25 pin D-Sub INTERLOCK on the IMS have to be connected for that. See tab. 1-2 for the pin assignments.*

---

### 1.3.6 Power-up Actions of the R&S IMS

Since there is no built-in controller in the R&S IMS, there is no boot. **The instrument can only be operated with the aid of a PC having a USB remote control interface and R&S IMS software. The iKey for this software is plugged into the instrument and is detected by the R&S IMS software when there is a USB connection between the R&S IMS and the PC.**

If a powered up R&S IMS is connected to a booted PC via the USB interface, the USB hubs in the R&S IMS are activated and this is indicated by an audible signal on the PC.

The active USB interfaces can be checked from the PC with the aid of the menu sequence Start\Settings\Control Panel\System\Device Manager\USB Controllers.

---

**Note:** *Before starting the R&S EMC32 software the R&S IMS should be switched to the ON mode and then connected to the booted PC via USB cable so that Windows can activate the USB drivers. The R&S EMC32 software should not be started until then.*

---

### 1.3.7 Switching Off

---

**Note:** *Before switching off the R&S IMS the R&S EMC32 application should be closed and the USB cable should be disconnected from the PC. Only when this has been done, the R&S IMS should be switched to STBY mode or entirely disconnected from the AC supply by means of the main power switch.*

---

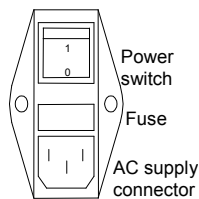

- Press the ON/STBY switch on the front panel for at least 2 seconds.

The AC supply switches to the STBY mode.

The USB hub and the INTERLOCK circuit are supplied with operating voltage via power supply unit 2 only.

The yellow LED 1 must be on.

**Warning:**

The AC supply is still connected to the instrument in STBY mode.



To disconnect the instrument completely from the AC supply:

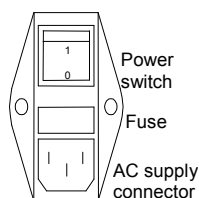

- Press the main power switch at the rear of the instrument to position 0. None of the front-panel LEDs should be on.

## 1.4 Function Checks

The Integrated Measurement System R&S IMS automatically monitors the operating voltages in the instrument and indicates an undershoot or overshoot of the voltage tolerance thresholds by switching POWER LED 4 to red.

Moreover in the event of an error when starting the software and/or starting a test, the software displays an error message.

No further function checks or error displays are available.

## 1.5 Connecting the Power Sensor

Up to three R&S NRP-Z91 power sensors with USB interface can be connected to the R&S IMS. The sensors are connected to a USB interface, type A, on the rear panel of the instrument.

---

**Note:** *Before connecting an instrument to the PC via the USB interface, it is essential to make sure that the corresponding USB drivers have been installed.*

---

The sensors are detected automatically once they are connected. The sensor(s) then need only be physically enabled in the instrument configuration of the R&S EMC32 software by means of their serial numbers.

## 1.6 Connecting Amplifiers

Up to three amplifiers with USB interface, supplied by the Bonn company, can be connected to the R&S IMS. One of these amplifiers can be built into the R&S IMS in the case of model 04.

The amplifiers are connected to a USB interface on the rear panel of the instrument.

---

**Note:** *Before connecting an instrument to the PC via the USB interface, it is essential to make sure that the corresponding USB drivers have been installed.*

---

The amplifiers are detected automatically once they are connected. The amplifiers then need only be physically enabled in the instrument configuration of the R&S EMC32 software by means of their serial numbers.

The RF cabling needs to be installed according to the block diagram and the caption on the back panel (see also chapter 6).

A connection from the "Interlock" 25 pin D-SUB connector on the R&S IMS to the respective 15 pin D-SUB connectors (Remote Control) on the amplifiers is also needed (see also chapter 6). The pin assignment is shown in the table below:

<b>Name</b>	<b>R&amp;S IMS Interlock 25 pin D-Sub</b>	<b>Bonn PA1 Remote Control 15 pin D-Sub</b>	<b>Bonn PA2 Remote Control 15 pin D-Sub</b>	<b>Bonn PA3 Remote Control 15 pin D-Sub</b>
Interlock to PA1	8, 15	8, 15	—	—
Interlock to PA2	7, 14	—	8, 15	—
Interlock to PA3	6, 13	—	—	8, 15
Status RF IN PA1	5	2	—	—
Status RF IN PA2	9	—	2	—
Status RF IN PA3	17	—	—	2
General fault PA1	12	6	—	—
General fault PA2	4	—	6	—
General fault PA3	16	—	—	6
Interlock to test room door	1, 3	—	—	—
Test In Progress lamp	10, 11	—	—	—
Ground	24, 25	7, 14	7, 14	7, 14

Table 1-2 Pin assignment on the connecting cable for external amplifiers from the Bonn company



## 1.7 Connecting EUT Monitoring

**Caution:**

*The level on this interface must not exceed 0V / +5 V or the interface and the R&S IMS could be damaged.*

An external monitor with a TTL interface can be connected to the MONITORING connector on the rear panel of the R&S IMS.

The connector interface is described in Chapter 6.2.

With four TTL inputs and four TTL outputs, the R&S IMS provides you with the ability to use the R&S EMC32 application to monitor an EUT during a test by observing the level on this interface. In the event of an EUT NOGO, commands can be given to the item under test (e.g. Stimulus : Reset).

The "instrument" in the R&S EMC32 application for interacting with the EUT is called "DIO Monitoring" (see also chapter 5.3.5, Equipment Test with Coupling/Decoupling Network and EUT Monitoring).

## **1.8 Installing the Operating System**

This section contains instructions for installing, updating and starting the R&S IMS operating system, which is based on the EMC32 software platform. It tells you about installation, software configuration, starting the program and troubleshooting.

If however you encounter any problems during installation, please contact the Rohde & Schwarz support line as follows:

---

**Telephone:**            **+49 1805 124242**  
**Fax:**                    **+49 1805 13777**  
**E-mail:**                **CustomerSupport@rsd.rohde-schwarz.com**

## **1.9 Registering the License**

Before starting to use the EMC32 software, you should register with Rohde & Schwarz. By doing this you will be sure to receive support via our support line and regular information about the latest updates.

You can start registration from within EMC32 by calling the Help menu with the following sequence: ? → EMC32 on the Internet → Register now. To do this you must have connected your PC to the Internet.

Alternatively you can also open the registration form by using the Autostart program on the EMC32 CD and clicking on the Registration menu item.

To find your product ID go to the About EMC32 dialog which you can open via the Help menu. This information also appears in the opening dialog when you start EMC32. For your product ID to be displayed you must start the EMC32 software with the iKey supplied.

## 1.10 Installing the EMC32 Software

### 1.10.1 System Requirements

Before installing EMC32 you should make sure that your PC satisfies the following minimum system requirements:

- Windows XP operating system, SP2 or Microsoft Patch KB822603 installed
- Administrator rights
- PC with Pentium processor (2.4 GHz) or comparable
- 256 MB RAM (512 MB RAM recommended)
- 200 MB of available hard disk space
- Super VGA monitor, minimum screen resolution 1024 x 768 pixels, 65536 colors, higher resolution recommended
- Free USB port

There is no guarantee that the product will operate correctly unless all the above minimum system requirements are met.

### 1.10.2 Data Security and User Administration

For the sake of software data security the protective functions of the operating system listed in the system requirements must be used. The user administration built into EMC32 is not provided for the purpose of data security, but to ensure that "standard users" cannot change important settings within EMC32.

**Note:**



*System Administrators are strongly recommended to read the PDF document "**Data Security and User Administration**" in the Documentation folder on the CD before starting installation.*

### 1.10.3 Simplified User Administration

If the EMC system is to be operated by only a few users with a comparable level of knowledge, it may not be necessary to implement the security functions available in the operating system. In such a case it is up to the system owner to decide whether a logon and user list are necessary and whether the test data for the various users need be stored in different folders.

Details of the necessary settings can be found in the online help, chapter "**Data Security and User Administration**".

## 1.11 Installing the Software

**Note:**

*If a version of EMC32 is already installed, it must be uninstalled first. Please also comply with the explanations in the chapters "Updating the EMC32 Software" and "Uninstalling the EMC32 Software".*

### 1.11.1 Installing the R&S IMS Operating System

The information needed to carry out the installation and related procedures for EMC32 is provided via the **Autostart program** on the EMC32 CD-ROM. By the time you have completed the following steps the software will have been installed on your PC and will be ready to run.

**Starting installation:**

1. Shut down any other programs you are running.
2. Put the **EMC32 CD** into your CD-ROM drive. If the Autostart function on your system is enabled, the installation program starts automatically and you can skip steps 3 and 4.
3. Select **Run** from the **Start** menu.
4. Enter **D:\HTMLVIEW.EXE** (replace **D:** with the letter appropriate to your CD-ROM drive if different).
5. Click on the **Install IMS OS Software** button and follow the instructions on the screen.
6. When asked to choose the product, select **IMS OS Software**.

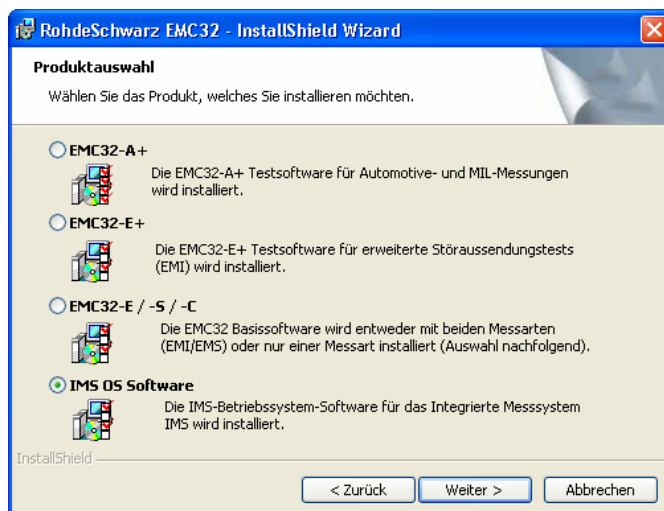

Fig. 1-4 Choosing the product in the installation program

7. In the next dialog the option R&S IMS Operating System Software is active. You can change the installation folder if you wish.

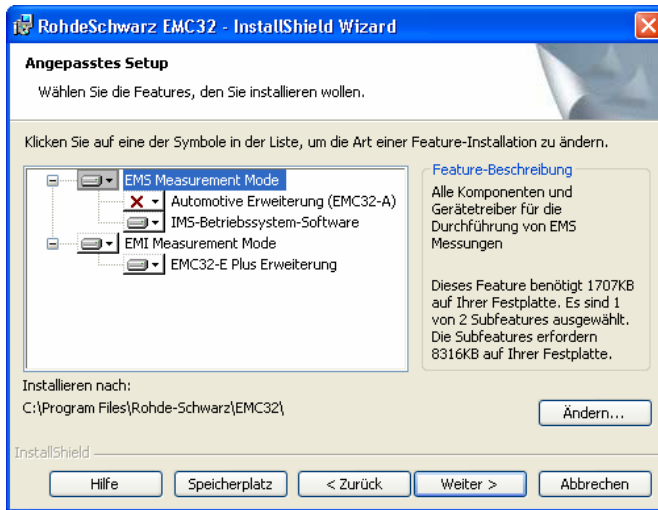

Fig. 1-5 Choosing the installation path in the installation program

8. Alternatively you can start the installation process by entering **D:\SETUP.EXE** (replace **D:** with the letter appropriate to your CD-ROM drive if different).

**Note:**

***It is not possible to install more than one instance of EMC32 on a PC.***

## 1.11.2 Installing USB Device Drivers

The next step is used for installing all the necessary USB Windows device drivers. This step is not necessary when installing a demo version without hardware.

**Note:**

***Do not plug in the R&S IMS before you have installed the USB Windows device drivers and when requested to do so in the subsequent instructions.***

The installation procedure can be run either via the **Autostart program** on the EMC32 CD-ROM or manually via the steps listed below.

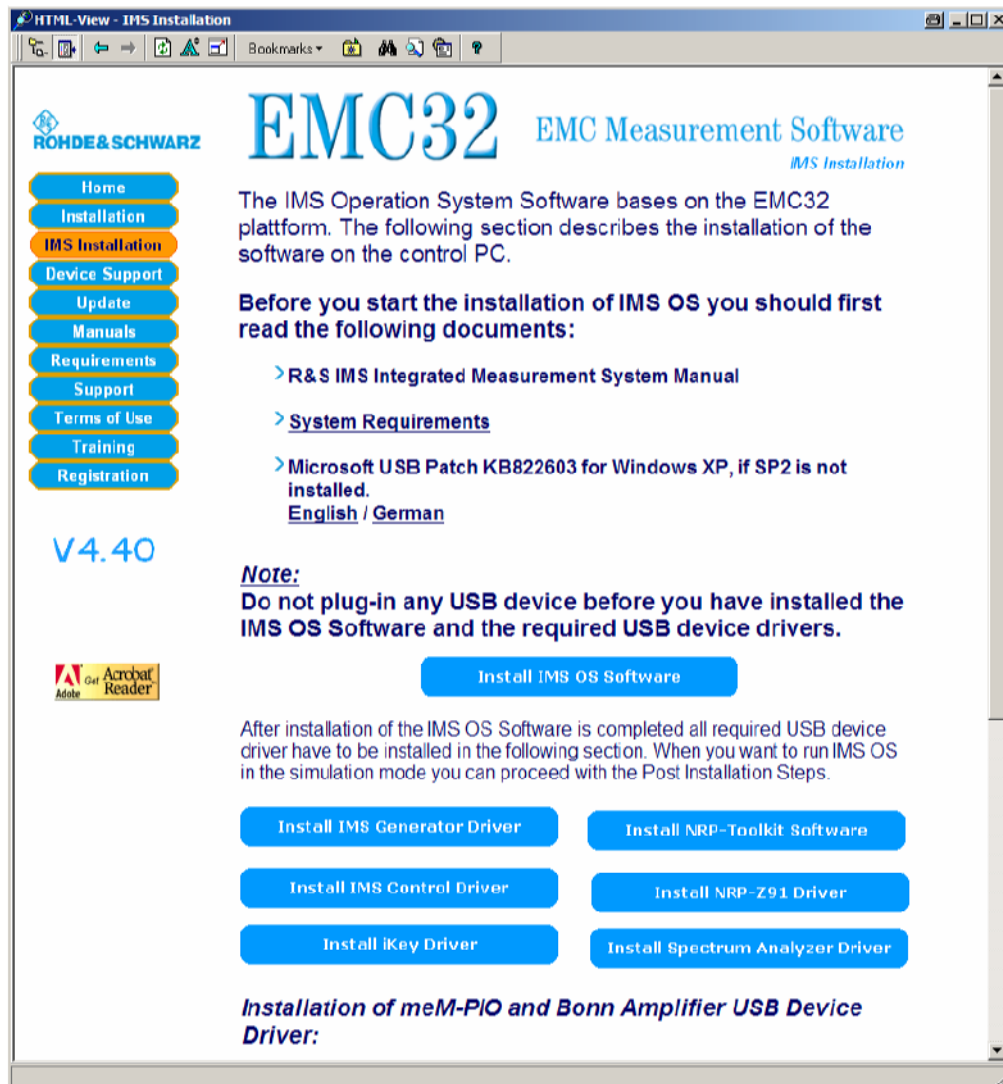

Fig. 1-6 Instructions for installing the USB drivers via the Autostart program

The following steps show you how to install the device drivers required for the R&S IMS. All such drivers are on the EMC32 CD-ROM.

**Driver for R&S IMS generator module:**

1. Start the program "*D:\SystemDrivers\SM300\rssism\_vxipnp\_1\_4.exe*", replacing "D:" with the letter appropriate to your CD-ROM drive if different.
2. Follow the instructions of the installation routine.

**Driver for R&S IMS analyser module (only for option IMS-B1):**

1. Start the program "*D:\SystemDrivers\IMS Analyzer\rssifs\_vxipnp\_1\_9.exe* ", replacing "D:" with the letter appropriate to your CD-ROM drive if different.
2. Follow the instructions of the installation routine.

**Driver for NRP-Z91 RF sensor:**

The installation for the NRP-Z91 RF sensor consists of two installation procedures:

1. Start the program "*D:\SystemDrivers\NRP-Zxx\Toolkit\Setup.exe*", replacing "D:" with the letter appropriate to your CD-ROM drive if different.
2. Follow the instructions of the installation routine.
3. Start the program "*D:\SystemDrivers\NRP-Zxx\rsnrpz\_vxipnp\_1\_18.exe*", replacing "D:" with the letter appropriate to your CD-ROM drive if different.
4. Follow the instructions of the installation routine.

**Driver for the meM-PIO I/O module:**

1. Start the program "*D:\SystemDrivers\MemPio\mem-actx-3.4.148.exe*", replacing "D:" with the letter appropriate to your CD-ROM drive if different.
2. Follow the instructions of the installation routine.
3. Now plug the R&S IMS into the system process controller and switch on the instrument at the mains switch on the rear panel.
4. The Windows utility for detecting new USB devices should now start automatically and report that it has found a new device of the "meM-PIO (USB Interface)" type.
5. At this point select Installation from a known source.
6. In the dialog that opens next, either select Find CD-ROM or choose the following path as the folder: "*D:\SystemDrivers\MemPio*", replacing "D:" with the letter appropriate to your CD-ROM drive if different.
7. If you continue the driver will be installed and you should receive a Windows message telling you that the driver has been successfully installed.

**Driver for the Bonn USB amplifier remote control (for R&S IMS with integrated amplifier module or external Bonn amplifier only):**

1. Now plug the R&S IMS into the system process controller and switch on the instrument at the mains switch on the rear panel if you have not already done so in the previous step.
2. The Windows utility for detecting new USB devices should now start automatically and report that it has found a new device of the "Bonn BSA 0125-251" type.
3. At this point select Installation from a known source.
4. In the dialog that opens next, either select Find CD-ROM or choose the following path as the folder: "*D:\SystemDrivers\BonnUsb*", replacing "D:" with the letter appropriate to your CD-ROM drive if different.
5. If you continue the driver will be installed and you should receive a Windows message telling you that the driver has been successfully installed.

**Driver for iKey software protection**

The EMC32 software is protected by a hardware key called **iKey**. This is integrated into the R&S IMS and contains the software license information. In order for EMC32 to work with the R&S IMS, the USB driver must previously have been installed.

1. Start the program "*D:\i\_Key\IKeyall.exe*", replacing "D:" with the letter appropriate to your CD-ROM drive if different.
2. Follow the instructions of the installation routine (when the installation program prompts you to connect the iKey, acknowledge the message. Restart the PC after quitting the installation).

To check that the software is working correctly proceed as follows:

After restarting, a utility program "iKey Token Utility" appears in the task bar and can be used to test whether the iKey has been recognized. Double-clicking on this icon starts the program and the dialog shown below appears. If the *serial number* of the iKey is displayed, it has been correctly recognized.

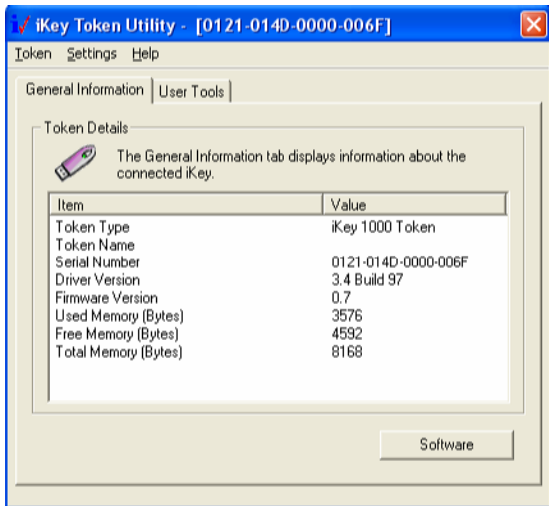

Fig. 1-7 Dialog for the iKey Token Utility program

## 1.12 Starting the Program

Following program installation you will find an EMC32 icon on your desktop. Double-click on this icon to start the software. You can of course also start the program via the Start button on the Windows desktop.

Starting the program via the Start button:

1. Click the **Start** button on your desktop.
2. Select **Programs – Rohde & Schwarz – EMC32 – EMC32**.

### Changing the language in EMC32:

The language for the EMC32 software can be changed during runtime, but the change only takes effect when the application is restarted. You can change the current language in the dialog for that purpose by choosing **Extras** → **Language...** menu.



## 1.13 EMC32 - IMS Configuration

Before you carry out a measurement with the R&S IMS, you have to adapt the software to your system. This means you must tell the EMC32 software which instruments are present in your system, which interfaces are used to address them, how the instruments are interconnected and how it is intended that the measurements obtained via these instruments shall be carried out.

For this purpose the EMC32 software includes a wizard (**Configuration wizard**), which prompts you for the required measurement modes (radiated/conducted) and the measuring instruments in your system, and then uses this information to create a standard configuration for the system. Correction tables and test templates are also copied to the appropriate folders, so that after this step the EMC32 software is ready for the start of the first **demo measurement**.

***Before you start your first real test equipment measurement, the corresponding calibration data for the antennas or transducers and for the signal paths must be entered or calibrated (for more details see also the chapter on system calibration in the online help).***

For more detailed notes on operating the configuration wizard please refer to chapter 5 "Examples of Measurements".

## 1.14 Updating the EMC32 Software

*Please follow the advice in the notes below when updating the software:*

When you update, the EMC32 system data and test results stay intact – the update affects only the program files (it is not necessary to uninstall). All the same, for safety's sake we recommend that you take a copy of all the test and calibration data that you have saved to the EMC32 folder. Use the Backup function in the File menu to create a copy of the **SYSTEM**, **TESTS** and **CONFIGURATION** folders in another location on your hard disk (such as in your *My Documents* folder), before carrying out the EMC32 update.

**To update the EMC32 software proceed as follows (unless you receive different instructions with the update):**

1. Shut down any other programs that are running.
2. Put the **EMC32 CD** into your CD-ROM drive. If the Autostart function on your system is enabled, the installation program starts automatically and you can skip steps 3 and 4.
3. Select **Run** from the **Start** menu.
4. Enter **D:\HTMLVIEW.EXE** (replace **D:** with the letter appropriate to your CD-ROM drive if different).
5. Click on the **Update EMC32 Software** button and follow the instructions on the screen. If you wish to install a measurement mode that you have not installed before at the same time as the update, enable it in the installation program dialog (see chapter Installing the EMC32 software).
6. Do **not** start the configuration wizard after successfully updating.
7. It is not necessary to uninstall and reinstall the iKey software.

## 1.15 Uninstalling the EMC32 Software

To uninstall the EMC32 software proceed as follows:

1. From the **Start** menu select **Settings – Control Panel**.
2. Double-click on the **Software** icon.
3. Click on **Add/Remove Programs**.
4. From the list of programs which you can uninstall, select **Rohde & Schwarz EMC32**.
5. Click on **Remove**.
6. The Windows Installer dialog now opens. Select **Remove** and confirm that you want to remove the EMC32 application (insert the EMC32 CD if the PC prompts you for it or click the **Cancel** button).

The uninstall program then deletes all program entries, folders and Registration database entries created during installation.

7. Once the files are deleted, you receive a message saying that the installation process is complete. Click **OK**.
8. Use Windows Explorer to delete the Rohde-Schwarz folder from the Program Files folder.

To uninstall the USB Windows drivers proceed as follows:

1. First close the **iKey Token Utility** program if it is active in the taskbar. 
2. From the **Start** menu select **Settings – Control Panel**.
3. Double-click on the **Software** icon.
4. Click on **Add/Remove Programs**.
5. If necessary remove the iKey and the R&S IMS from the USB port.
6. From the list of programs which you can uninstall, select **Rainbow iKey Components**. Click on **Remove**.
7. From the list of programs which you can uninstall, select **Rainbow iKey Driver**. Click on **Remove**.
8. From the list of programs which you can uninstall, select **Bonn USB Drivers**. Click on **Remove**.
9. From the list of programs which you can uninstall, select **NRP Toolkit**. Click on **Remove**.
10. From the list of programs which you can uninstall, select **Rohde & Schwarz, NRP-Z Driver**. Click on **Remove**.
11. From the list of programs which you can uninstall, select **Rohde & Schwarz, RSSISM Driver**. Click on **Remove**.
12. Only for option IMS-B1, analyzer module: From the list of programs which you can uninstall, select **Rohde & Schwarz, RSSIFS Driver**. Click on **Remove**.

## **1.16 Network Installation Tips**

The EMC32 application should normally be held in the Program Files folder on the Local Disk in Windows. However, system data such as measurement results, configuration and correction tables may be stored on a network server. If this is the case, make sure that a suitable network speed is installed, otherwise performance problems may occur when operating the EMC32 application.

First install the EMC32 software on the local disk as normal (you must have administrator rights). You can then change the paths for the EMC32 folder structure. For more detailed information please refer to the chapter **OPTIONS – File locations** in the **EMC32 online help**.

As a precondition you must have the necessary read/write access rights for the corresponding network drive.

If you are uncertain about any of the possible settings involved, please contact your network administrator for help with installing the EMC32 application.

## 1.17 Data Backup Instructions

It is recommended that measurement data and the system configuration should be backed up at regular intervals. When this is done, all selected EMC32 files are written to a compressed file in ZIP format.

Use **File >> Backup/Restore ...** to open the dialog for carrying out a backup or for restoring your files. The following functions can be selected:

- Select mode: Backup / Restore
- Select the EMC32 objects you want to back up or restore:
  - System folder
  - Tests folder
  - Configuration files
- Select the output ZIP file
- Select a temporary folder for the backup / restore procedure.

For more detailed information please refer to the chapter "Backing up or restoring data and configuration" in the EMC32 online help.

**Caution:**

The target folder for the ZIP file and the temporary folder must both have enough available disk space.

**Caution:**

*You can of course also archive (or move) individual files or complete tests from these folders. You should be aware, however, that the EMC32 application will then no longer be able to access these files or tests. Moving important calibration data or configuration files can also make it impossible to open or run a test. For further information on the EMC32 file structure please refer to the appropriate section of the online help.*

## 1.18 Troubleshooting

Problems may occasionally occur during installation. Here are some troubleshooting tips to help you solve the commonest situations. If you have any further questions, please contact Rohde & Schwarz Support or look through the Readme file.

- Before starting to install the application you should close all programs, particularly virus protection programs. Virus protection programs normally have little or no effect on the installation process. However, if such software is running and you experience problems when installing the EMC32 application, you should close the virus protection program and run the installation again.
- If in the course of installation you receive a message telling you that a Windows DLL is in use and therefore cannot be updated, press OK to confirm so that the installation will continue. Normally this does not cause any problems.
- Delete all files from your temporary folder. (This folder is defined by the environment variable TEMP, which normally has the value C:\TEMP or C:\WINDOWS\TEMP.)
- Run a disk checking program on your hard drive. Hard drive faults can cause problems during the installation process. (Some Microsoft Windows systems include a utility program called ScanDisk. If you have any queries about disk checking programs, please contact your system administrator.)
- Copy the EMC32 installation CD to your hard disk and start SETUP.EXE from there.
- Check that you have enough free space available on your hard disk. (The installation process will tell you if there is not enough available disk space when you start of the installation procedure.)
- In the Regional Options under the Numbers and Currency tabs always use "." rather than "," as the decimal separator. Do not use the symbol "," in groups of numbers (use a blank character instead).

## 2 Manual Operation

### 2.1 Manual Operation

The Integrated Measurement System R&S IMS has no means of entering settings on the front panel. All settings must be entered by means of the operating system software, since there is no built-in intelligence.

However, the software can be used to operate the individual modules "manually".

---

**Note:** *A dialog with the instruments is only possible when the interlock is closed. Contacts 1 and 3 of the 25 pin D-Sub INTERLOCK on the IMS have to be connected for that. See tab. 1-2 for the pin assignments.*

---

1. Connect the PC and the R&S IMS by means of USB cable
  2. Start the R&S EMC32 software on the PC
  3. Call *Selftest* from the EXTRAS menu
  4. Click the *Test All* button → All the instruments in the system are physically enabled
  5. Double click on the required instrument
  6. Select the Test tab
  7. The predefined settings or switch commands can now be selected. Then click on the fields labeled  
Button  
Setting  
Run  
Analyze
- to run them.

---

**Note:** *Only one instrument dialog can be opened at a time. To open another dialog the first dialog must be closed.*

---

---



## 3 Instrument Functions

### 3.1 Introduction

This chapter describes the individual function blocks of the R&S IMS, using the names given in block diagram 1502.0009.01 S S 1+2 or circuit diagram.

### 3.2 Instrument Functions

The Integrated Measurement System R&S IMS is a complete EMS test system for acceptance tests to civil, military and automotive standards from 9 kHz to 3 GHz.

It offers the following functions in a 4 HU 19" instrument:

- Signal source
- Signal change
- Power measurement
- Controlling and switching up to three amplifiers including interlock
- R&S IMS operating system: Fully compliant test software for EMS and EMI measurements
- Integrated amplifier
- Spectrum analyzer

In addition the R&S ESCI and R&S ESPI receivers are both supported for EMI measurements.

Furthermore the following modules are housed in the R&S IMS for the purpose of internal communication between these function blocks:

- a USB hub with 13 USB outputs (8 external, 5 internal)
- an I<sup>2</sup>C control module for switching the relay
- a voltage monitoring module on the front panel for nine operating voltages
- a USB/TTL interface chip (memPIO) for three 8-bit TTL IN/OUT ports

The eight external USB outputs are provided for: 3 x amplifiers, 3 x R&S NRP-Z91, iKey dongle, reserve  
The five internal USB outputs are provided for: generator, analyzer, power supply unit, iKey dongle, memPIO.

## R&S IMS

### Signal generation

The generator is built into the R&S IMS as an A4 module. There is also a matched A5 power supply unit. Both modules are remotely controlled by means of an internal USB interface. Analog modulation types AM, FM, PH and pulse are available from the generator module. A built-in LF generator provides the modulation frequencies, but can also deliver its signal externally.

With the R&S IMS-B3 option (generator interlock relay) a 50 Ohm termination can be applied in the RF line to the RF switching unit in place of the generator signal in the event of an open interlock circuit.

### Power measurement

The R&S NRP-Z91 power sensor is used for measuring forward power and reflected power as well as for monitoring the injected current (BCI) for example. The system can be switched between forward power, reflected power and monitoring via a fast and wear-free K4 PIN diode switch.

As an option, additional power sensors can be used (option R&S IMS-B7 required).

The power sensor(s) are connected externally to the USB outputs via the R&S NRP-Z4 adapter cable.

### Spectrum analyzer

Frequency-selective power measurement is available with the optional R&S IMS-B1 spectrum analyzer. For example the harmonic components of the amplifier can be observed at the 1 dB compression point. A further application is current monitoring for the BCI method in the automotive area (checking the first five harmonics). Remote control of the analyzer module uses an internal USB port. The generator power supply unit also provides the analyzer module with the necessary voltages.

### RF switching unit

The RF switching unit together with relays K1 to K3 switches all R&S IMS RF paths over for up to three amplifiers. The remote control uses the generator power supply unit and the I<sup>2</sup> bus. All three relays are switched simultaneously with one command, so that only one amplifier with RF input, forward power and reflected power is ever connected to the R&S IMS.

The transfer relay (option R&S IMS-B2) can be used to switch two amplifier outputs to two different transducers (e.g. antennas, current clamps) or connection points (e.g. in anechoic chambers and shielded enclosures).

### Internal amplifier module (R&S IMS, model 04)

An internal amplifier module (R&S IMS model 04) with a frequency range of 9 kHz to 250 MHz is available for conducted measurements. The amplifier power of 25 W (CW lin) enables measurements to be taken with coupling/decoupling networks (CDN) at 10 V test voltage to EN 61000-4-6.

The amplifier operates independently, has its own power supply unit and is remotely controlled via an external USB port.

### External amplifiers

Amplifiers with authorized USB control (e.g. from Bonn Elektronik GmbH) can be integrated into the system with the aid of exactly the same connections as the internal amplifier. Other amplifiers can be controlled by using the GPIB upgrade (option R&S IMS-B4). A total of three amplifiers can be controlled and switched.

**Interlock**

The R&S IMS operating system supports the monitoring of an interlock circuit for checking safety functions during EMS measurement, such as door contacts and amplifier status. A K6 relay in the R&S IMS is set by means of a short-circuit-proof +12V supply via a door contact. This relay in turn activates the R&S IMS-B3 option (generator interlock relay), releases the amplifier and issues a message to the R&S EMC32 operating system.

**Test-in-progress relay**

At the start of a test a K7 test-in-progress relay closes a floating relay contact which can be made to switch on say an illuminated sign on the test room door.

**EUT monitoring**

The R&S IMS has four digital inputs (D8 MemPIO) for monitoring the EUT during an EMC test. These inputs can be polled individually or as a group. Four digital outputs are provided for EUT stimulus (static values or pulse signal).

**USB hub**

The USB hub is provided by means of the 4 port USB hub modules D9, D11, D12, D13 and the current monitoring modules D14, D15, D16. The current monitoring modules limit the current on the USB interface to < 1 A. The USB ports are only activated when a connection exists to a USB host (PC).

**Voltage monitoring**

Voltage monitoring for the nine operating voltages used in the system is built into the LED board on the front panel. A +/- tolerance threshold for each voltage is provided via OPs. This tolerance is used in continuous monitoring and if the voltage value goes above or below this value the "POWER" LED on the front panel turns red. At the same time a status message is sent to the operating system via D8 (memPIO) and is output during initialization and at the start of a test.

**Upgrade for EMI measurements**

Rohde & Schwarz test receivers R&S ESCI and R&S ESPI are supported for EMI measurements. A GPIB interface is required for this purpose (R&S TS-PIEC2). Other test receivers and spectrum analyzers can be integrated with the aid of the R&S IMS-B4 option (which upgrades the R&S IMS operating system to R&S EMC32-A+).



## 4 Applications

### 4.1 Introduction

The following chapter contains an overview of some possible examples of R&S IMS applications, listed according to various standards.

Starting from a basic configuration with R&S IMS model 02, hardware setups are shown and the additional components needed in order to operate them are listed.

The R&S IMS model 02 without an internal amplifier has space in the empty amplifier compartment on the right for further expansion modules such as EUT monitoring.

### 4.2 Applications

#### R&S IMS basic configuration

- Integrated EMC Measurement System R&S IMS model 02
- Power sensor R&S NRP-Z91
- USB adapter R&S NRP-Z4
- Process controller (PC)
- Cable set (USB and RF cables)

#### 4.2.1 Commercial Standards

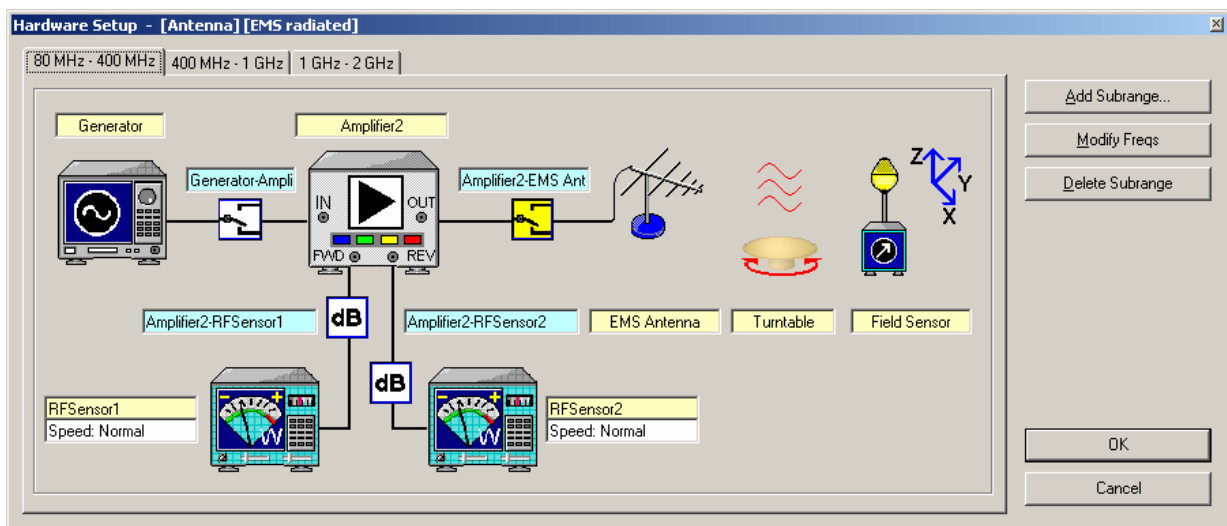

#### EN 61000-4-3: Radiated susceptibility in anechoic chamber, 80 MHz to 2 GHz, 10 V/m at 80 % AM

- R&S IMS basic configuration
- Antenna R&S HL046E
- Suitable amplifier
- Field-strength measurement system

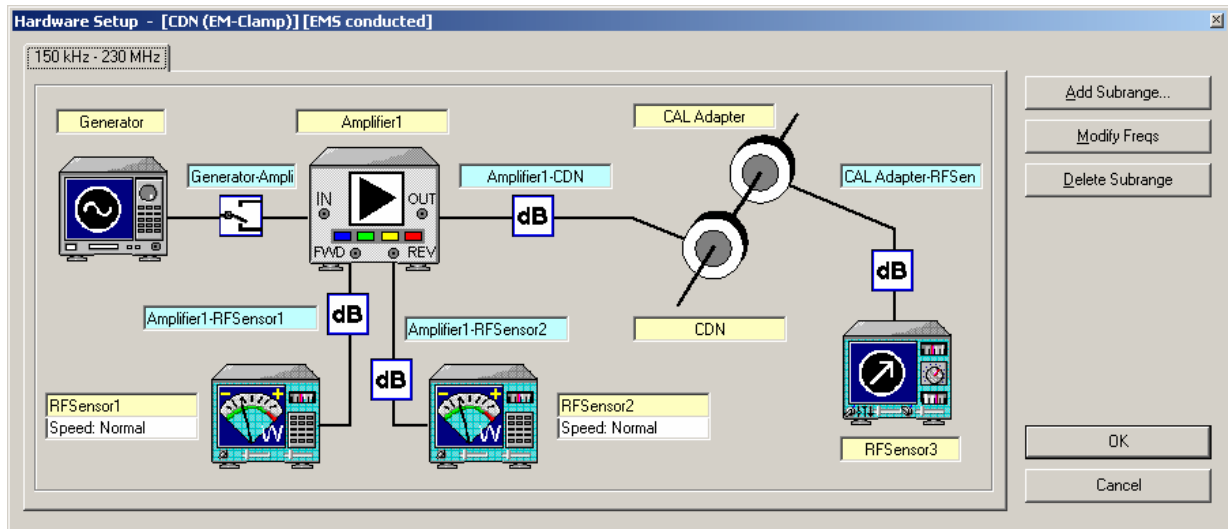

**EN 61000-4-6: Conducted susceptibility with CDN, 150 kHz to 230 MHz, 10 V**

- R&S IMS basic configuration with R&S IMS model 04 with internal amplifier 9 kHz to 250 MHz, 25 W
- CDN suited to the EUT

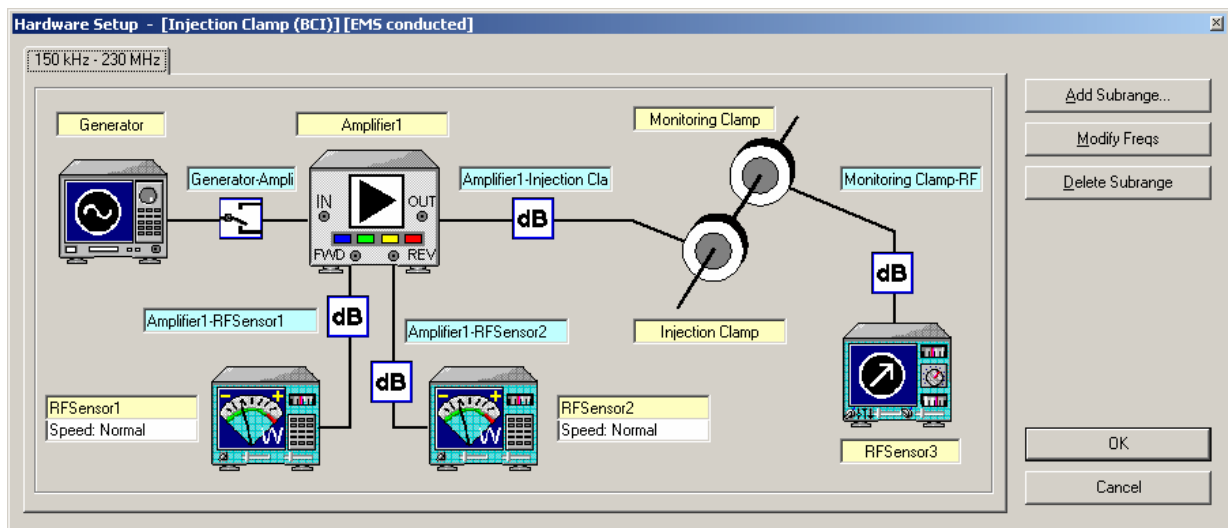

**EN 61000-4-6: Conducted susceptibility with EM clamp, 150 kHz to 230 MHz, 10 V**

- R&S IMS basic configuration
- EM clamp
- Suitable amplifier

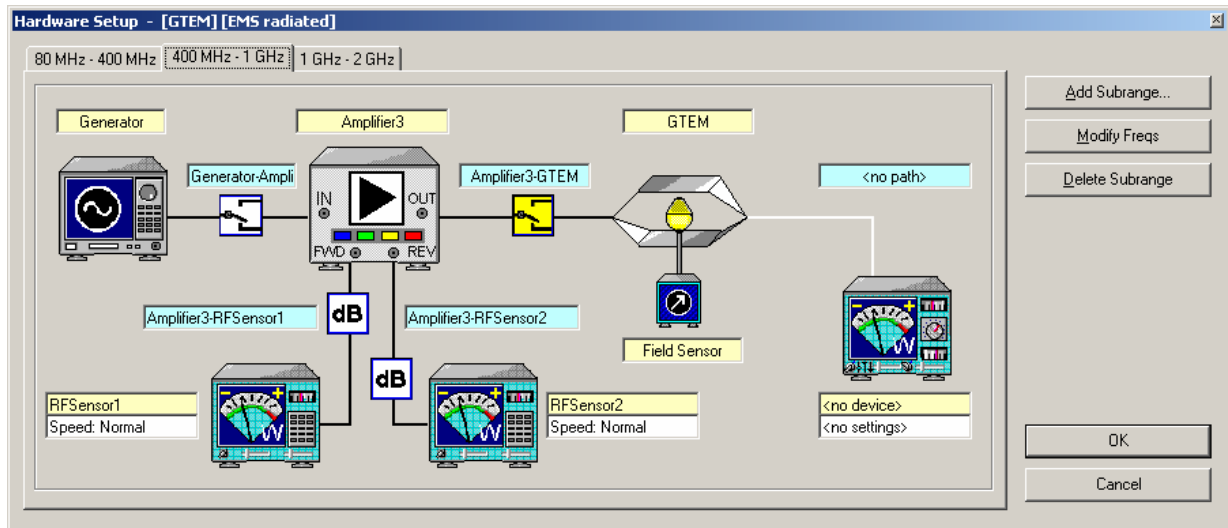

#### EN 61000-4-20: Radiated susceptibility with GTEM cell, 80 MHz to 2 GHz, 10 V/m at 80 % AM

- R&S IMS basic configuration
- GTEM cell
- Suitable amplifier
- Field-strength measurement system

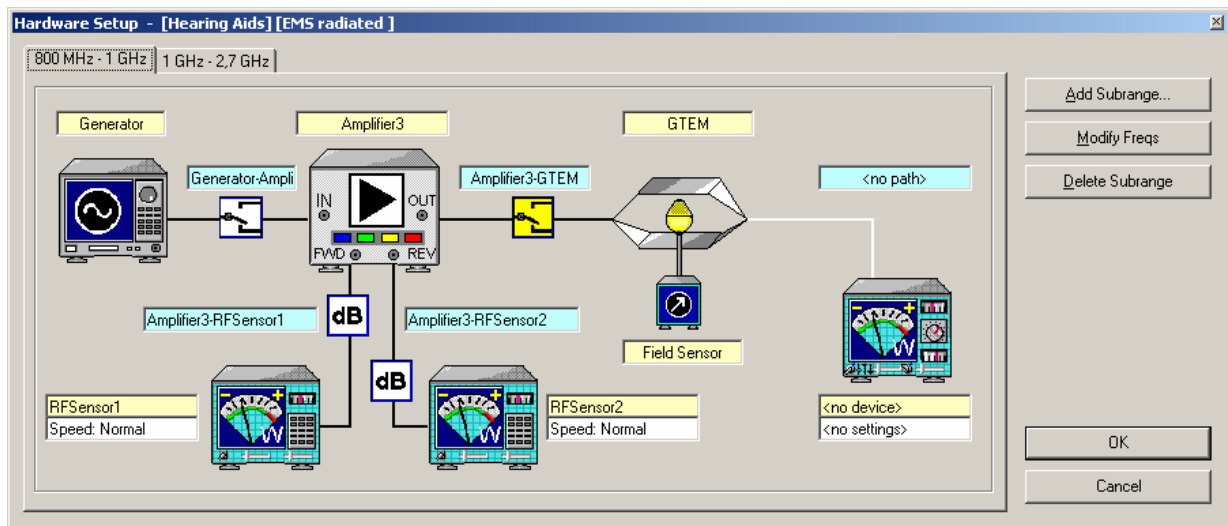

#### EN 60118-13: Susceptibility of hearing aids, frequency range 800 MHz to 2.7 GHz

- R&S IMS basic configuration
- GTEM cell with EUT positioning device
- Suitable amplifier
- Audio analyzer R&S UPL
- R&S IMS-B4 upgrade to R&S EMC32-A+ incl. GPIB interface for USB
- Adapter
- Microphone

### 4.2.2 Military Standards

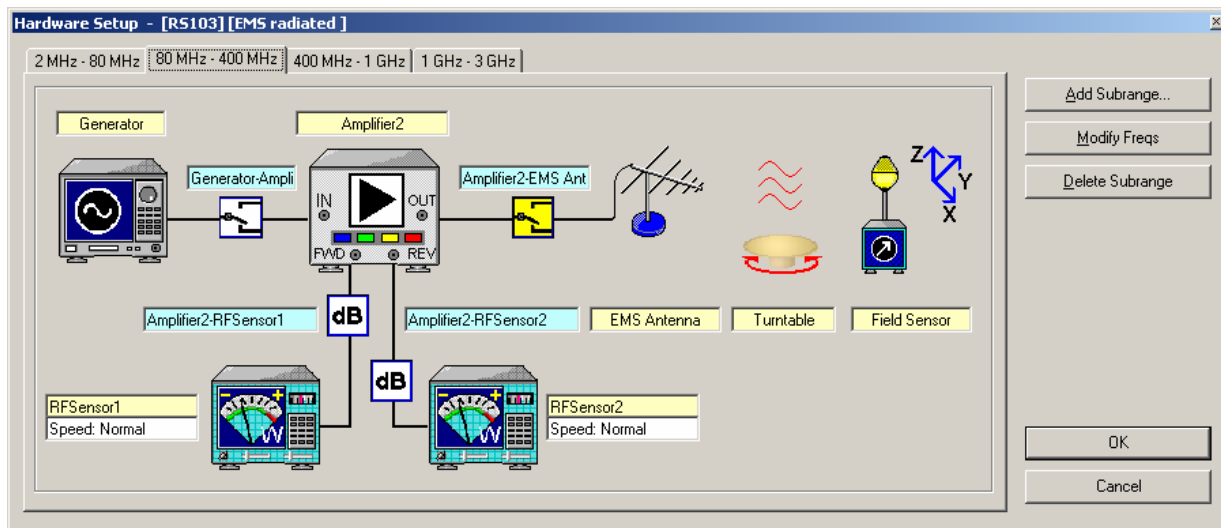

**MIL 461E: Radiated susceptibility RS103, 2 MHz to 3 GHz**

- R&S IMS basic configuration
- Suitable amplifier
- Antenna
- Field-strength measurement system

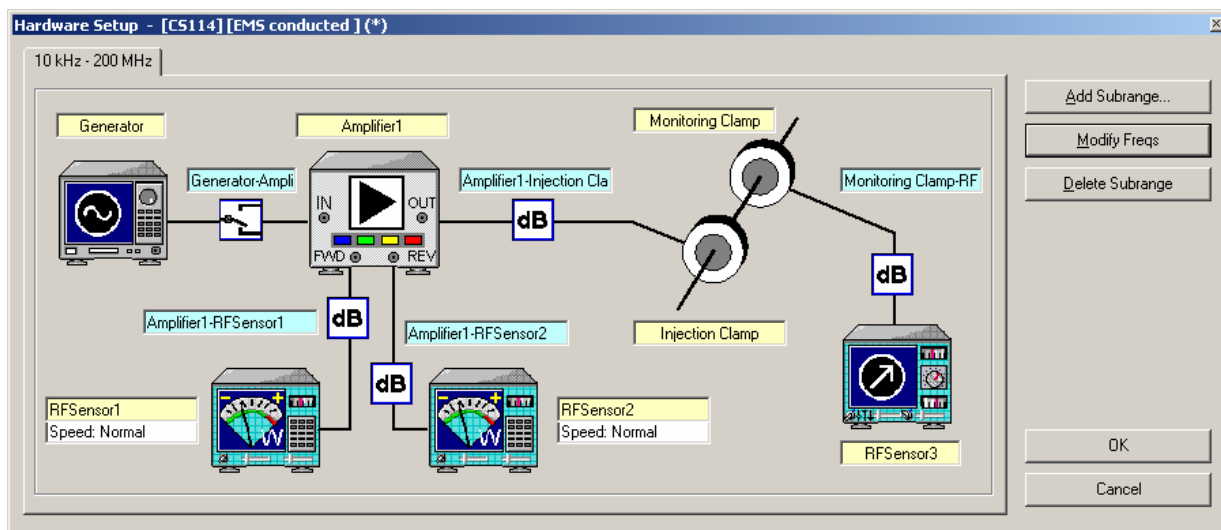

**MIL 461E: Conducted susceptibility CS114 (bulk cable injection), 10 kHz to 200 MHz**

- R&S IMS basic configuration
- Suitable amplifier
- Coupling and monitoring current clamps



### 4.2.3 Automotive Standards

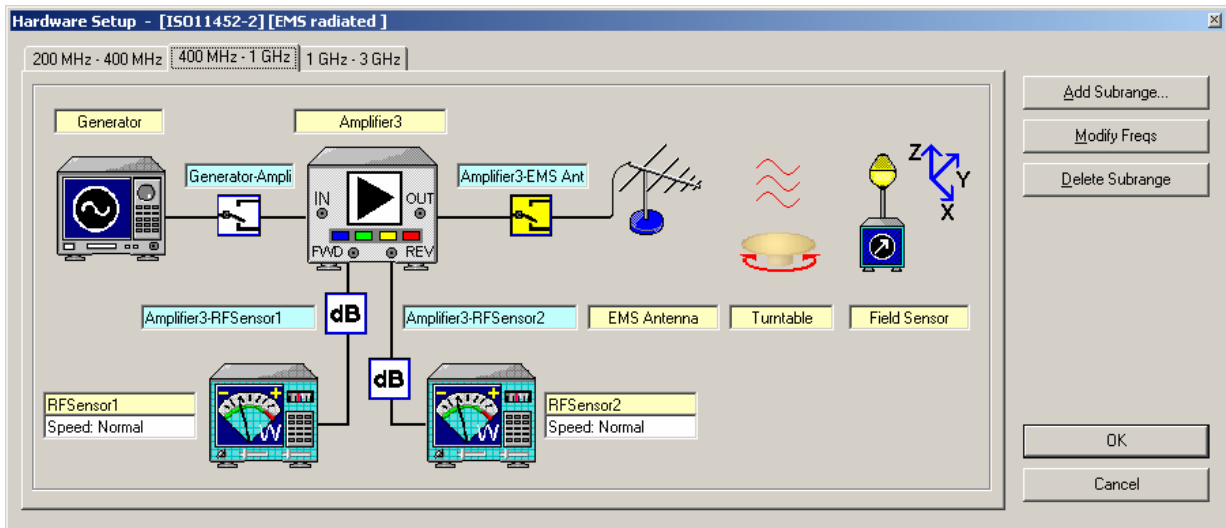

#### ISO 11452-2: Radiated susceptibility in anechoic chamber, 200 MHz to 3 GHz, 100 V/m

- R&S IMS basic configuration
- Antenna
- Suitable amplifier
- Field-strength measurement system

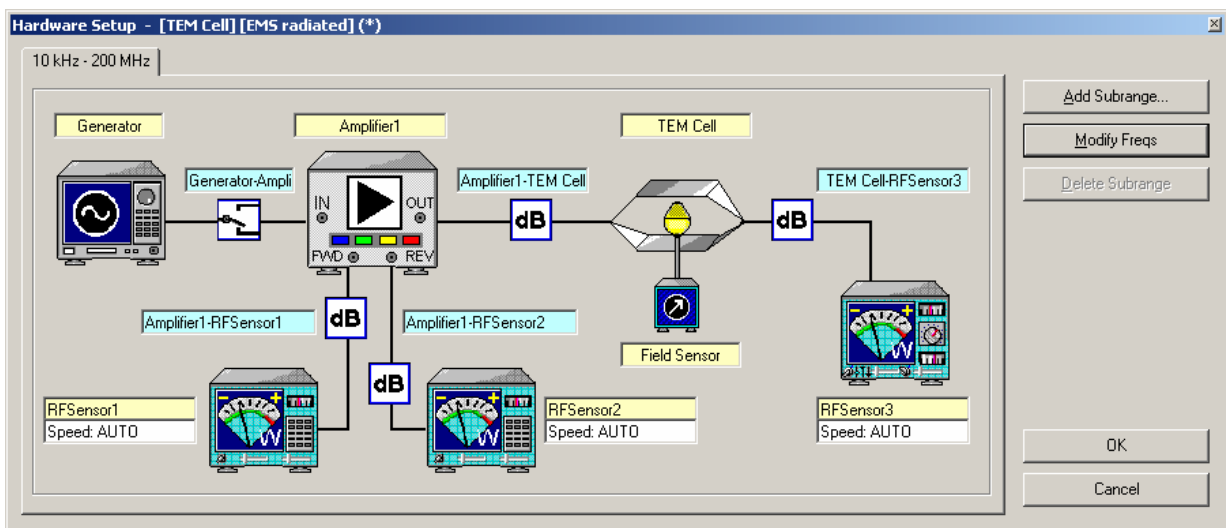

#### ISO 11452-3: Conducted susceptibility with TEM cell, 10 kHz to 200 MHz, 200 V/m

- R&S IMS basic configuration
- TEM cell
- Suitable amplifier
- Field-strength measurement system

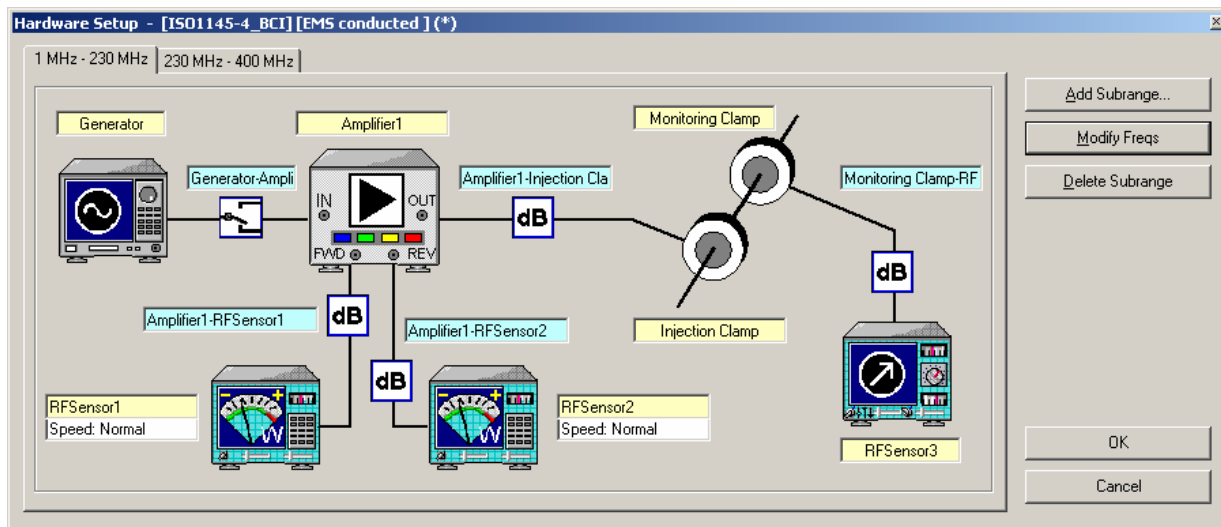

**ISO 11452-4: Conducted susceptibility with BCI method, 1 kHz to 400 MHz, 300 mA**

- R&S IMS basic configuration
- Suitable amplifier
- Coupling and monitoring current clamps

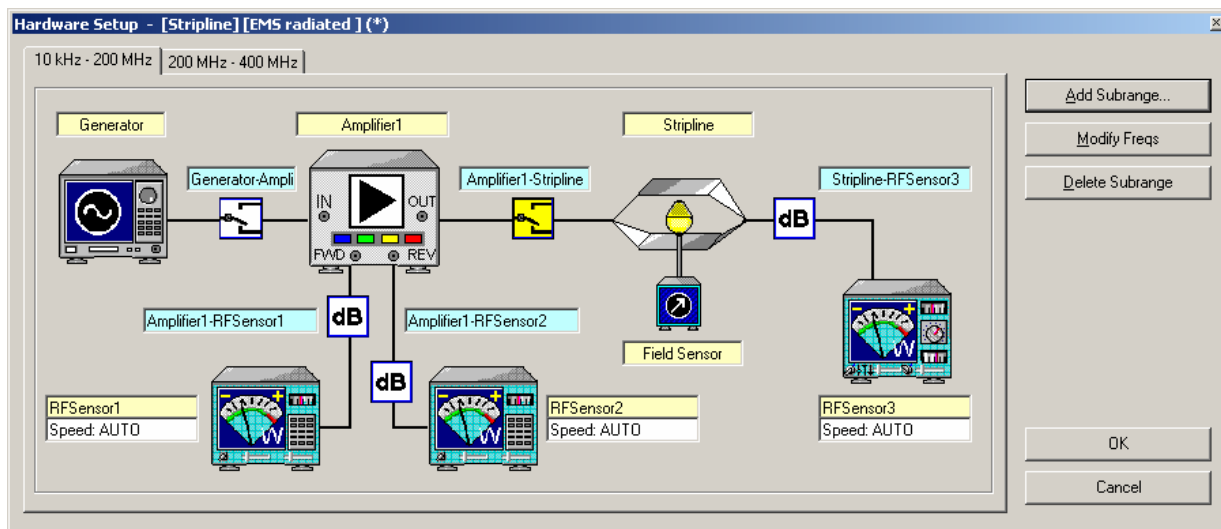

**ISO 11452-5: Radiated susceptibility with stripline, 10 kHz to 400 MHz, 200 V/m**

- R&S IMS basic configuration
- Stripline
- Suitable amplifier
- Field-strength measurement system

# 5 Examples of Measurements

## 5.1 Introduction

This chapter describes the use of the R&S IMS for measuring immunity to electromagnetic interference according to different EMC standards. The following points are dealt with in respect of each standard:

- Test setup in the system
- Software configuration
- Calibrating signal paths
- Reference calibration procedure
- Performing equipment tests

Further details on configuration and on operating the EMC32 software (operating the editors and test control elements) can also be found in the EMC32 online help which you can open by clicking ? on the Help menu. You will also find a reference to the EMC32 application note for the described standards together with additional detailed instructions.

**Note:**

*Before connecting the computer with the R&S IMS via the USB link, all USB drivers of the R&S IMS Application have to be installed. In addition the interlock must be closed. Contacts 1 and 3 of the 25 pin D-Sub INTERLOCK on the IMS have to be connected for that. See tab. 1 2 for the pin assignments.*

## 5.2 Measurement to EN 61000-4-3 (Radiated)

This section describes the use of the R&S IMS for measurements to generic standard EN 61000-4-3.

### 5.2.1 Test Setup for External Dual Band Amplifiers

This application uses the R&S IMS with an external dual band amplifier covering a frequency range of 80 MHz to 1 GHz. The amplifier power is sufficient, when the log-periodic antenna is used, to carry out tests with a test level of 10 V/m at a distance of 3 m.

The illustration below shows how the system can be configured using few additional components:

- R&S NRP-Z91 RF sensor with R&S NRP-Z4 USB adapter
- Dual band amplifier with internal input and output switching matrix
- Log-periodic antenna in the frequency range 80 MHz to 1 GHz
- Field probe with fiber-optic transmission and RS-232-C PC interface
- RF and USB cable set

System process controller with R&S IMS operating system (EMC32)

-

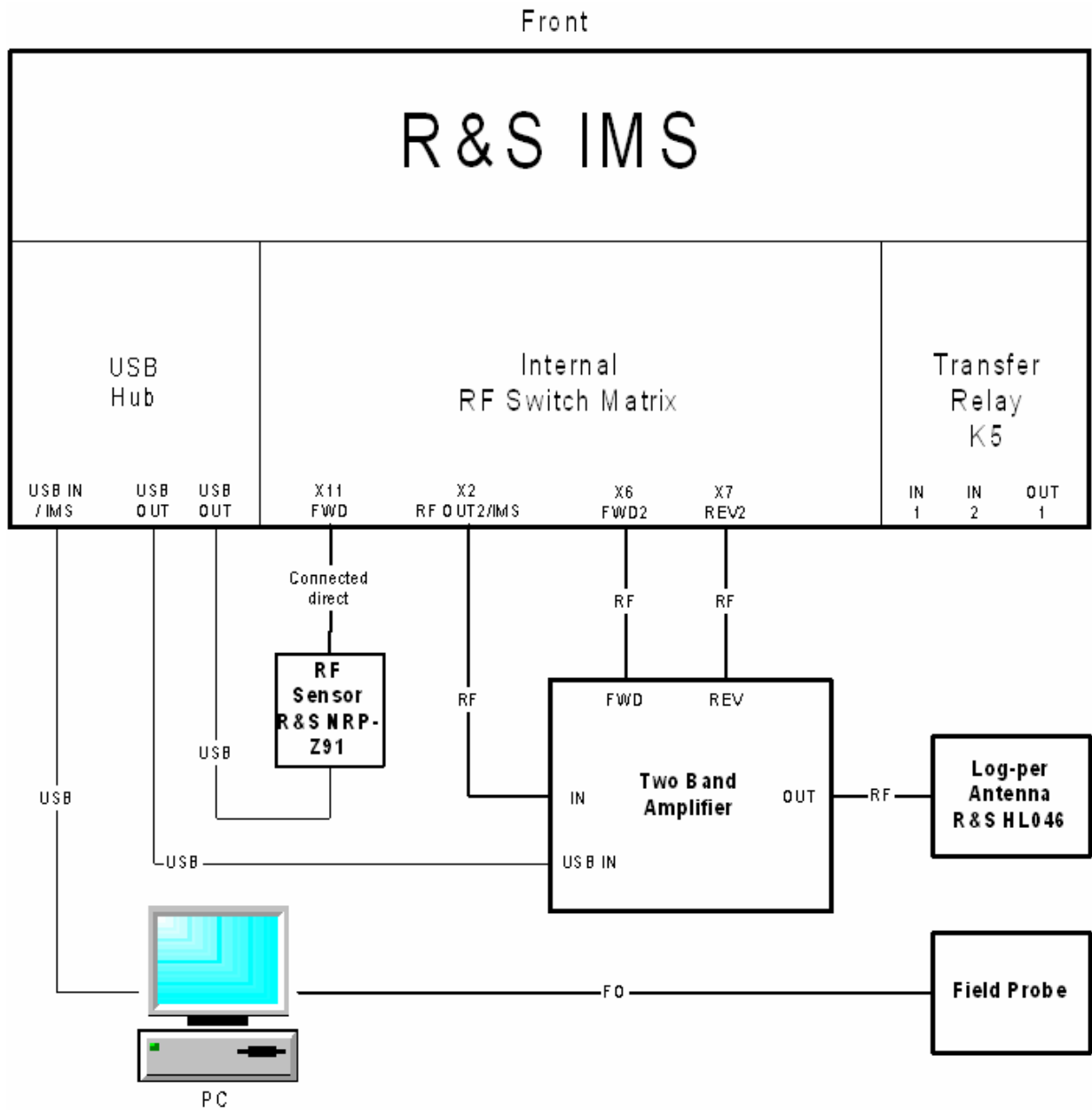

Fig. 5-1 Test setup to EN 61000-4-3 with a dual band amplifier in a single RF sensor configuration

The above figure shows the system setup for carrying out calibration and the subsequent test equipment measurement. The field probe is not needed for this, since the substitution method is used. Because of the PIN diode switch integrated in the R&S IMS, the system can be operated using **one** RF sensor. This switches the input for the forward RF power and the input for the reflected RF power to the RF sensor as appropriate.

## 5.2.2 Configuring the Software for Dual Band Amplifiers

In the first step after installing the EMC32 operating system software for the R&S IMS, you have to adapt the software to your system. This means you must tell the EMC32 software which instruments are present in your system, which interfaces are used to address them, how the instruments are interconnected and how it is intended that the measurements obtained via these instruments shall be carried out.

For this purpose the EMC32 software includes the **R&S IMS configuration wizard**, which prompts you for the instruments present in the system and then creates a standard configuration for the system. Correction tables and test templates are also copied to the appropriate folders.

To start the R&S IMS configuration wizard proceed as follows:

1. Start the EMC32 application.
2. If the opening dialog is enabled, you will see that it contains an icon that will open the wizard.

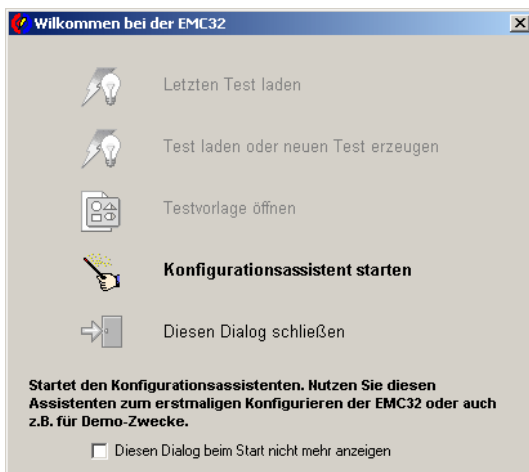

Fig. 5-2 Opening dialog for the EMC32 software

3. Otherwise open the wizard via the menu: **Extras – Wizard – IMS Configuration**.
4. The following dialog opens. Measurement class *EMS radiated* will be selected for EN 61000-4-3.

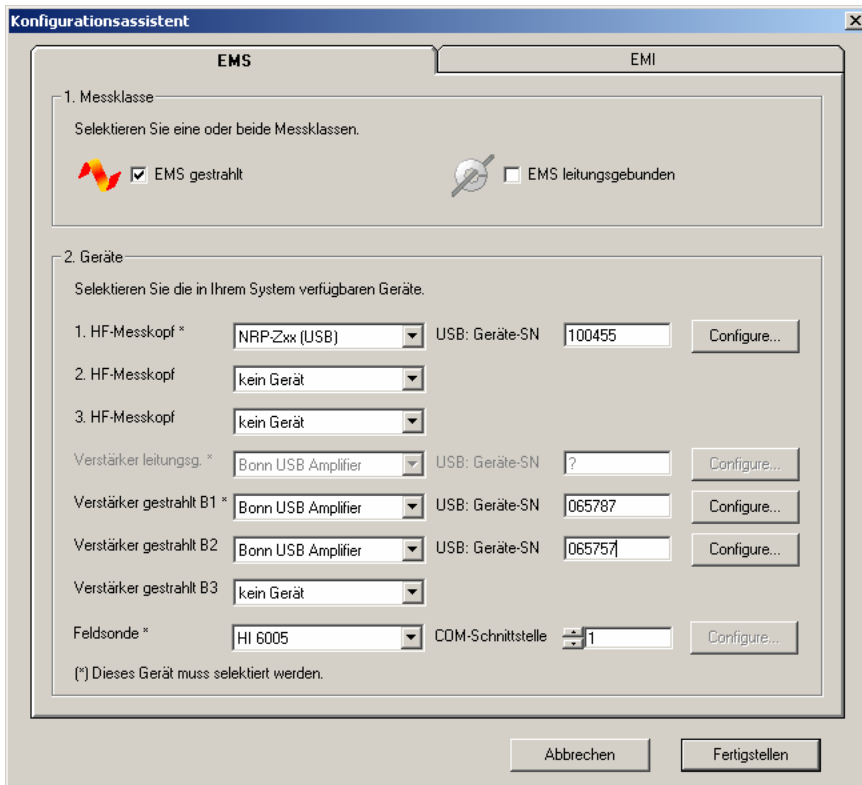

Fig. 5-3 Dialog in the R&S IMS configuration wizard (EMS radiated)

5. In this example the chosen configuration is One RF Sensor. Sensors 2 and 3 are therefore not selected. The serial number of the R&S NRP-Z91 sensor that will be used can be entered in the *USB instrument SN* field. If this number is not known, a '?' can be entered. When using a different sensor from the NRP-Zxx product family, this can be changed in the *Configure...* dialog.
6. Each band in the dual band amplifier is treated as a separate amplifier. Lastly enter the serial number of the external Bonn amplifier that will be controlled via the USB port. To use a different type of amplifier, select *Generic Amplifier* as the device driver in place of the *Bonn USB Amplifier* type. The amplifier parameters can be adapted in the *Configure...* dialog.

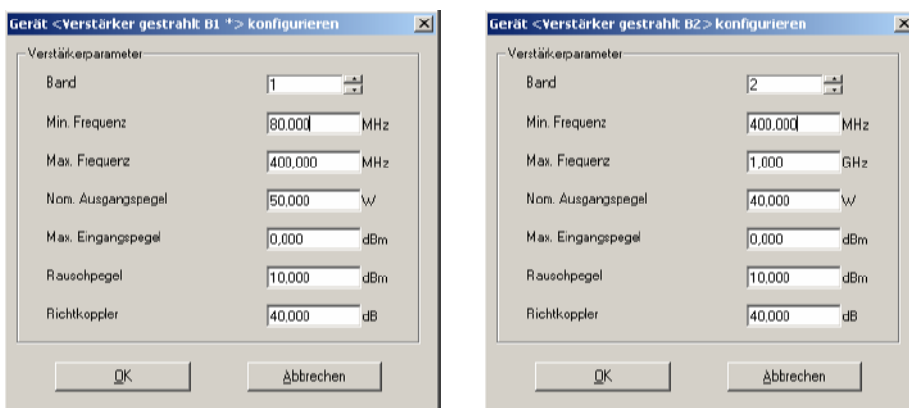

Fig. 5-4 Dialog for configuring both bands in the Bonn dual band amplifier

7. Having completed all the entries, click on the **Finish** button to run the configuration procedure.
8. When the configuration wizard has closed, the EMC32 application must be restarted.

**Note:**

The EMC32 software is now ready to begin the first demo measurement. Before you can carry out the first test equipment measurement, it is necessary to calibrate the signal paths and measure the field uniformity with the log-periodic antenna.

9. As well as the configuration for measuring with the aid of an EMS antenna, the wizard also creates a configuration for an amplifier test on the dual band amplifier. For more details on these configurations please refer to the Application Notes for EN 61000-4-3 in the EMC32 online help.
10. The wizard creates an EMC32 list of equipment containing the following instruments:

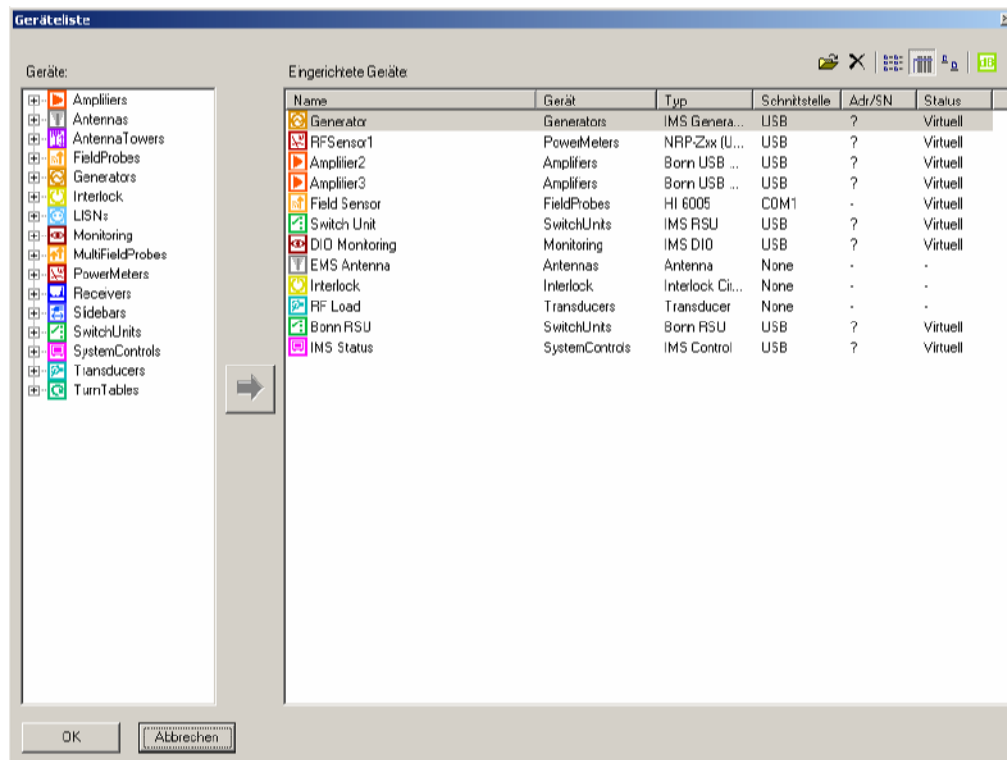

Fig. 5-5 Equipment list created by the configuration wizard for EMS radiated

The following table contains short descriptions of the device driver functions:

Instrument name	Description
Generator	For controlling the internal R&S IMS generator module
RFSensor1	For controlling RF sensor NRP-Z91
Amplifier2	For controlling band 1 of the external Bonn amplifier (1st amplifier for radiated measurements)
Amplifier3	For controlling band 2 of the external Bonn amplifier (2nd amplifier for radiated measurements)
Field Sensor	For controlling the field strength sensor used
Switch Unit	For controlling the internal RF switching matrix
DIO Monitoring	For controlling the R&S IMS EUT Monitoring interface for test equipment monitoring and stimulation
EMS Antenna	For defining the physical limit values of the log-periodic antenna used
Interlock	For monitoring the interlock input

Instrument name	Description
RF Load	For defining the physical limit values of the RF terminating impedance for the amplifier test
Bonn RSU	For controlling the internal RF switching matrix of the dual band amplifier
IMS Status	For controlling the R&S IMS status display on the front panel

Table 5-1 List of the instruments entered in the equipment list by the configuration wizard

### 5.2.3 Signal Path Calibration for Dual Band Amplifiers

In the second step the supplementary RF cable must be calibrated in order to increase measurement accuracy. This is done with the aid of the signal path calibration tools incorporated in the EMC32 software.

**Note:** *With the option R&S IMS-B3 included, the interlock needs to be closed for calibrations in order to allow the generator level to appear at the outputs RF OUT 1 to RF OUT 3/IMS.*

During signal path calibration the frequency-dependent damping behavior of a signal path in the test system is determined and saved to a file of the *damping correction table* type. The settings used when measuring a signal path are held in a file of the *calibration configuration* type. A dedicated dialog box has been provided for defining these settings.

There are two possible ways of opening this dialog:

- From the Explorer by double-clicking on an existing calibration configuration or by clicking once with your right mouse button on the Calibration Configurations folder and clicking once on **New File** in the context menu.
- By clicking on the **Calibration** button in the Properties dialog of a signal path that has been called out from an instrument configuration. This call has been provided so that an instrument configuration can be fully and consistently created in a single process. If a number of correction tables are specified, a selection dialog opens first so that you can select the table requiring calibration.

The following signal paths require calibration for this measurement application:

Path name	From	To	Remarks
Generator-Amplifier2	Output X2 RF OUT 2/IMS of the R&S IMS	Input of the external dual band amplifier	
Amplifier2-RFSensor1(FWD)	Output FWD of the dual band amplifier	Output X11 FWD via input X6 FWD 2	
Amplifier2-RFSensor1(REV)	Output REV of the dual band amplifier	Output X11 FWD via input X7 REV 2	
Amplifier2-EMS Antenna	Output cable of the dual band amplifier	Input of the log-periodic antenna	
Directional Coupler			The manufacturer's



Path name	From	To	Remarks
Factor Amplifier2			calibration values are used
Generator-Amplifier3	Output X2 RF OUT 2/IMS of the R&S IMS	Input of the external dual band amplifier	
Amplifier3-RFSensor1(FWD)	Output FWD of the dual band amplifier	Output X11 FWD via input X6 FWD 2	
Amplifier3-RFSensor1(REV)	Output REV of the dual band amplifier	Output X11 FWD via input X7 REV 2	
Amplifier3-EMS Antenna	Output cable of the dual band amplifier	Input of the log-periodic antenna	
Directional Coupler Factor Amplifier3			The manufacturer's calibration values are used

Table 5-2 List of signal paths

To calibrate the signal paths shown in the above table, proceed as follows:

1. From the EMS radiated instrument configuration open the "IMS radiated" file.
2. Left click on the icon for the signal path "Generator-Amplifier2" in order to open the Properties dialog of that signal path.
3. Start signal path calibration by clicking on the Calibration radio button in the dialog. All settings for calibration in the signal path calibration editor are already preconfigured. Start calibration by pressing the *Calibration* button.
4. For normalization connect the RF sensor to output X2 RF OUT 2/IMS.
5. For signal path measurement insert the cable between output X2 RF OUT 2/IMS and the amplifier input between output X2 RF OUT 2/IMS and the RF sensor. For more detailed information on using the signal path calibration tools in EMC32, please refer to the chapter System Calibration – Signal Path Calibration in the EMC32 online help.
6. Calibrate the other signal paths in the same way.

To enter the calibration values for the directional coupler factor proceed as follows (assuming it is measurable):

1. Create a new damping correction table via File → New Table.
2. Enter the correction values or import them from a file.
3. Save the file.
4. From the EMS radiated instrument configuration open the "IMS radiated" file.
5. Left click on the icon for the amplifier titled "Amplifier2" in order to open the Properties dialog of that amplifier.
6. In the Directional Coupler field change the fixed value damping correction in the file.
7. Carry out steps 1 – 6 for amplifier 3.

### 5.2.4 Test Setup for Two External Amplifiers

This application uses the R&S IMS with built-in transfer relay together with two external amplifiers which together cover a frequency range of 80 MHz to 1 GHz. The amplifier power should be sufficient, when the log-periodic antenna is used, to create tests in respect of field uniformity using a test level of 10 V/m at a distance of 3 m.

The illustration below shows how the system can be configured using few additional components:

- 2 x R&S NRP-Z91 RF sensor with NRP-Z4 USB adapter
- External amplifier with a frequency range of 80 MHz to 400 MHz
- External amplifier with a frequency range of 400 MHz to 1 MHz
- Log-periodic antenna in the frequency range 80 MHz to 1 GHz
- Field probe with fiber-optic transmission and RS-232-C PC interface
- RF and USB cable set
- System process controller with R&S IMS operating system (EMC32)

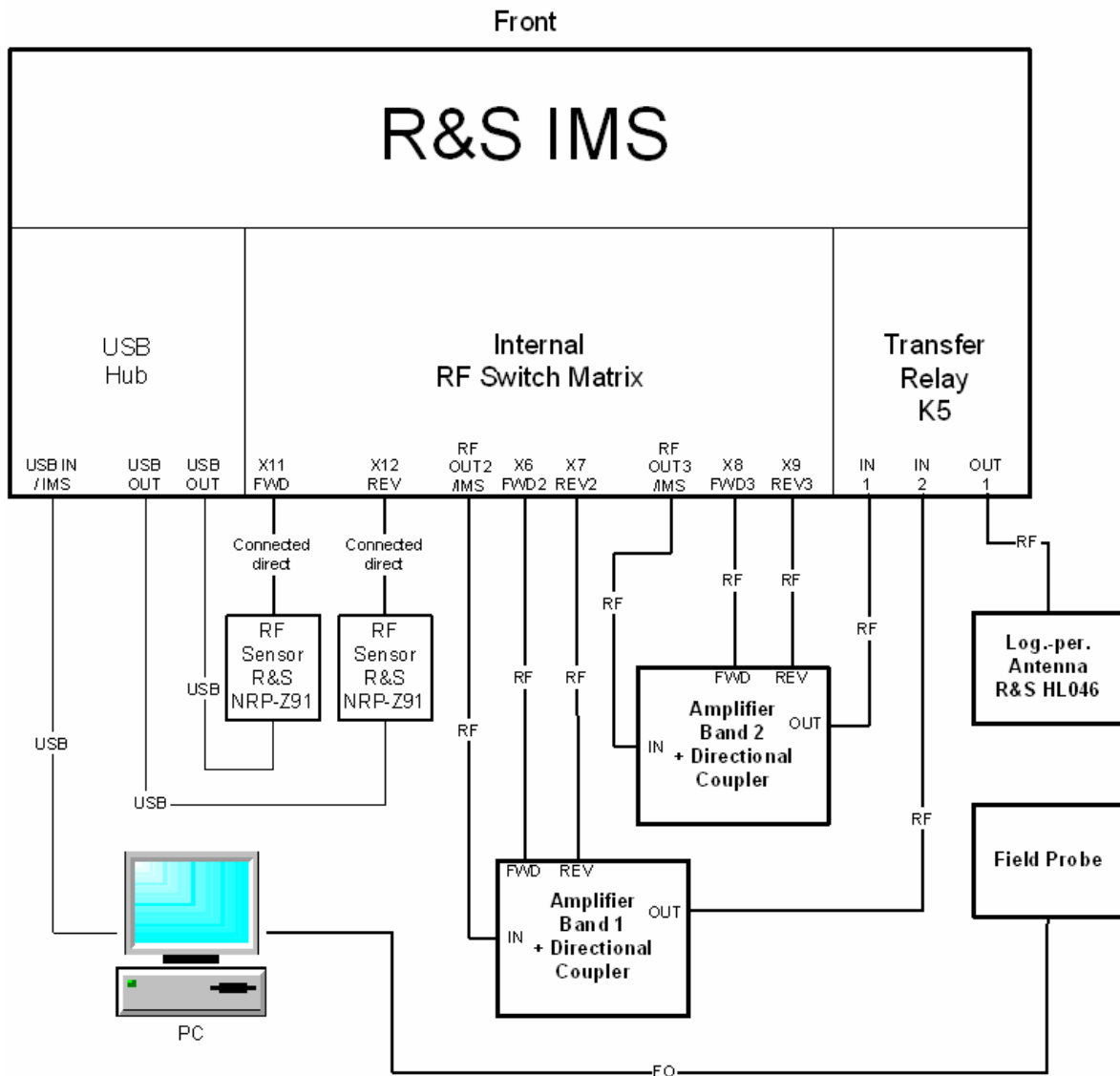

Fig. 5-6 Test setup to EN 61000-4-3 with two external amplifiers in a two RF sensor configuration

The above figure shows the system setup for carrying out calibration and the subsequent test equipment measurement. The field probe is not needed for this, since the substitution method is used. In the R&S IMS in Two Sensor configuration, the nominal forward power inputs are hard wired into the X11 FWD output by means of a relay. The integral PIN diode switch is used for signal conversion between the reflected power and the monitoring input for conducted measurements. In our application example however, it is hard wired into the reflected power.

## 5.2.5 Configuring the Software for Two External Amplifiers

In the first step after installing the EMC32 operating system software for the R&S IMS, you have to adapt the software to your system. This means you must tell the EMC32 software which instruments are present in your system, which interfaces are used to address them, how the instruments are interconnected and how it is intended that the measurements obtained via these instruments shall be carried out.

For this purpose the EMC32 software includes the **R&S IMS configuration wizard**, which prompts you for the instruments present in the system and then creates a standard configuration for the system. Correction tables and test templates are also copied to the appropriate folders.

To start the R&S IMS configuration wizard proceed as follows:

1. Start the EMC32 application.

If the opening dialog is enabled, you will see that it contains an icon that will open the wizard.

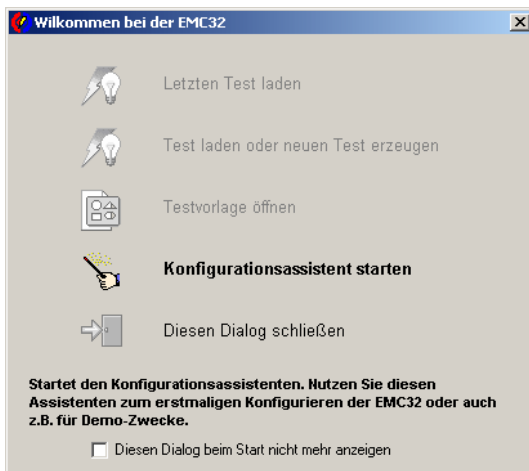

Fig. 5-7 Opening dialog for the EMC32 software

2. Otherwise open the wizard via the menu: **Extras – Wizard – IMS Configuration**.
3. The following dialog opens. Measurement class *EMS radiated* will be selected for EN 61000-4-3.

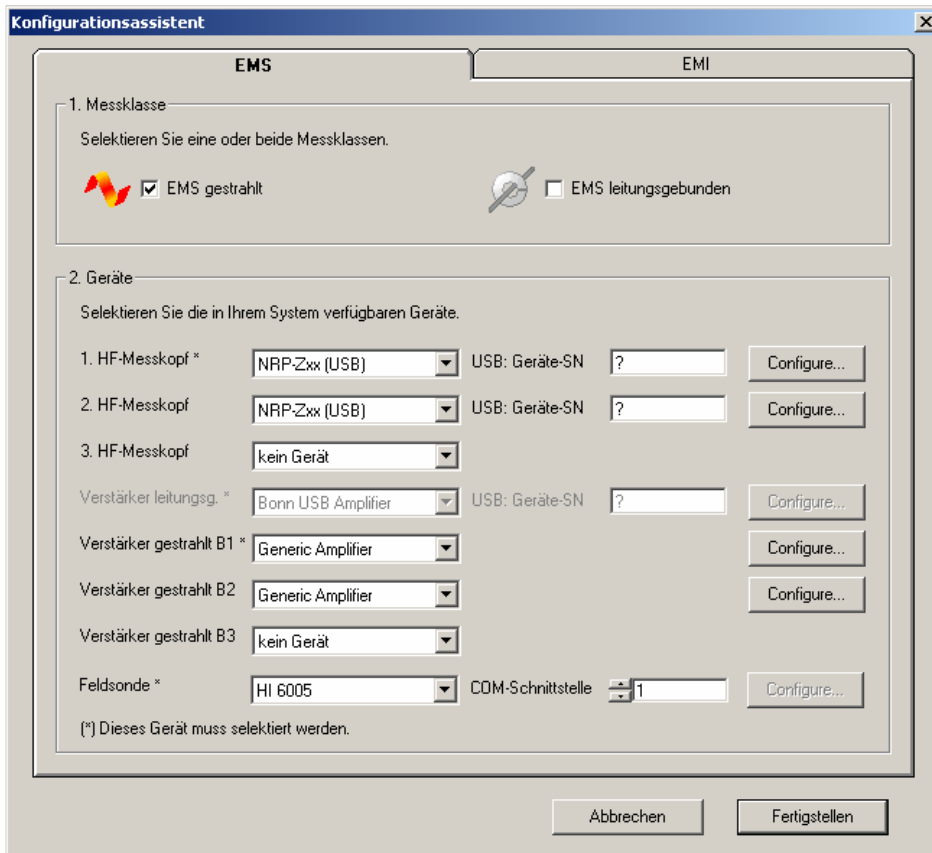

Fig. 5-8 Dialog in the R&S IMS configuration wizard (EMS radiated)

4. In this example the chosen configuration is Two RF Sensor. Sensors 1 and 2 are therefore selected. Enter the serial numbers of the R&S NRP-Z91 sensors that will be used in the *USB instrument SN* field. When using a different sensor from the NRP-Zxx product family, this can be changed in the *Configure...* dialog.
5. Select "Generic Amplifier" as the device driver for both external amplifiers. The amplifier parameters can be adapted in the *Configure...* dialog.

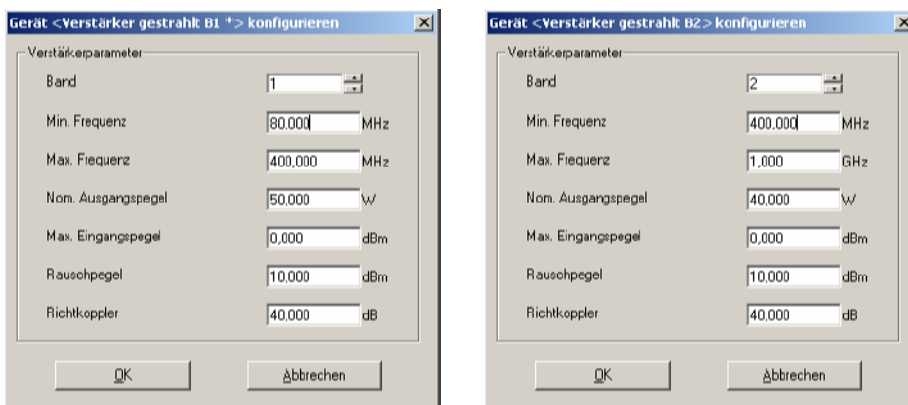

Fig. 5-9 Amplifier configuration dialog for radiated measurement

6. Having completed all the entries, click on the **Finish** button to run the configuration procedure.
7. When the configuration wizard has closed, the EMC32 application must be restarted.

**Note:**

The EMC32 software is now ready to begin the first demo measurement. Before you can carry out the first test equipment measurement, it is necessary to calibrate the signal paths and measure the field uniformity with the log-periodic antenna.

8. As well as the configuration for measuring with the aid of an EMS antenna, the wizard also creates a configuration for an amplifier test on the two amplifiers. For more details on these configurations please refer to the Application Notes for EN 61000-4-3 in the EMC32 online help.
9. The wizard creates an EMC32 list of equipment containing the following instruments:

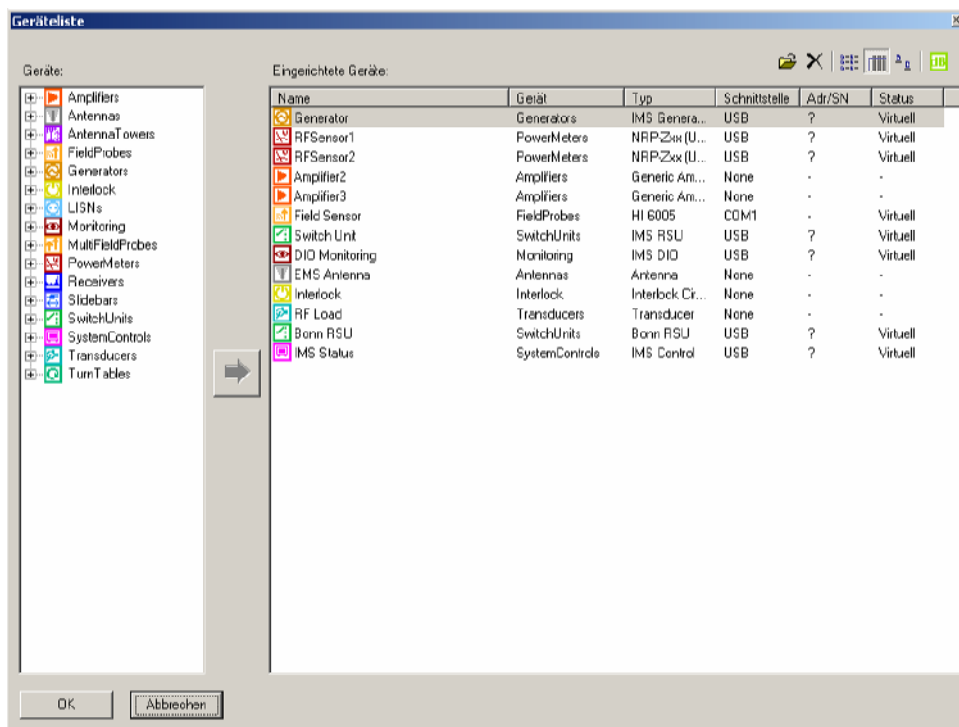

Fig. 5-10 Equipment list created by the configuration wizard for EMS radiated

The following table contains short descriptions of the device driver functions:

Instrument name	Description
Generator	For controlling the internal R&S IMS generator module
RFSensor1	For controlling the RF sensor NRP-Z91 for forward power
RFSensor2	For controlling the RF sensor NRP-Z91 for reflected power
Amplifier2	For controlling band 1 of the external amplifier (1st amplifier for radiated measurements)
Amplifier3	For controlling band 2 of the external amplifier (2nd amplifier for radiated measurements)
Field Sensor	For controlling the field strength sensor used
Switch Unit	For controlling the internal RF switching matrix
DIO Monitoring	For controlling the R&S IMS EUT Monitoring interface for test equipment monitoring and stimulation
EMS Antenna	For defining the physical limit values of the log-periodic antenna used

Instrument name	Description
Interlock	For monitoring the interlock input
RF Load	For defining the physical limit values of the RF terminating impedance for the amplifier test
IMS Status	For controlling the R&S IMS status display on the front panel

Table 5-3 List of the instruments entered in the equipment list by the configuration wizard

### 5.2.6 Signal Path Calibration for Two External Amplifiers

In the second step the supplementary RF cable must be calibrated in order to increase measurement accuracy. This is done with the aid of the signal path calibration tools incorporated in the EMC32 software.

**Note:** *With the option R&S IMS-B3 included, the interlock needs to be closed for calibrations in order to allow the generator level to appear at the outputs RF OUT 1 to RF OUT 3/IMS.*

During signal path calibration the frequency-dependent damping behavior of a signal path in the test system is determined and saved to a file of the *damping correction table* type. The settings used when measuring a signal path are held in a file of the *calibration configuration* type. A dedicated dialog box has been provided for defining these settings.

There are two possible ways of opening this dialog:

- From the Explorer by double-clicking on an existing calibration configuration or by clicking once with your right mouse button on the Calibration Configurations folder and clicking once on **New File** in the context menu.
- By clicking on the **Calibration** button in the Properties dialog of a signal path that has been called out from an instrument configuration. This call has been provided so that an instrument configuration can be fully and consistently created in a single process. If a number of correction tables are specified, a selection dialog opens first so that you can select the table requiring calibration.

The following signal paths require calibration for this measurement application:

Path name	From	To	Remarks
Generator-Amplifier2	Output X2 RF OUT 2/IMS of the R&S IMS	Input of the external amplifier band 1	
Amplifier2-RFSensor1(FWD)	Output FWD of the external amplifier band 1	Output X11 FWD via input X6 FWD 2	
Amplifier2-RFSensor1(REV)	Output REV of the external amplifier band 1	Output X12 REV via input X7 REV 2	
Amplifier2-EMS Antenna	Output cable of the external amplifier band 1	Input of the log-periodic antenna	Via the transfer relay
Directional Coupler Factor Amplifier2			Enter manufacturer data or calibrate using the calibration function of the EMC32 software

Path name	From	To	Remarks
Generator-Amplifier3	Output X3 RF OUT 3/IMS of the R&S IMS	Input of the external amplifier band 1	
Amplifier3-RFSensor1(FWD)	Output FWD of the external amplifier band 2	Output X11 FWD via input X8 FWD 3	
Amplifier3-RFSensor1(REV)	Output REV of the external amplifier band 2	Output X12 REV via input X9 REV 3	
Amplifier3-EMS Antenna	Output cable of the external amplifier band 2	Input of the log-periodic antenna	Via the transfer relay
Directional Coupler Factor Amplifier3			Enter manufacturer data or calibrate using the calibration function of the EMC32 software

Table 5-4 List of signal paths

To calibrate the signal paths shown in the above table, proceed as follows:

1. From the EMS radiated instrument configuration open the "IMS radiated" file.
2. Left click on the icon for the signal path "Generator-Amplifier2" in order to open the Properties dialog of that signal path.
3. Start signal path calibration by clicking on the *Calibration* radio button in the dialog. All settings for calibration in the *signal path calibration* editor are already preconfigured. Start calibration by pressing the *Calibration* button.
4. For normalization connect the RF sensor to output X2 RF OUT 2/IMS.
5. For signal path measurement insert the cable between output X2 RF OUT 2/IMS and the amplifier input between output X2 RF OUT 2/IMS and the RF sensor. For more detailed information on using the signal path calibration tools in EMC32, please refer to the chapter System Calibration – Signal Path Calibration in the EMC32 online help.
6. Calibrate the other signal paths in the same way.

To enter the calibration values for the directional coupler factor proceed as follows (assuming it is measurable):

1. From the EMS radiated instrument configuration open the "IMS radiated" file.
2. Left click on the icon for the amplifier titled "Amplifier2" in order to open the Properties dialog of that amplifier.
3. Enter a name for the directional coupler and in the *Directional Coupler* field change the fixed value damping correction in the file.
4. Close the Properties dialog.
5. Left click on the icon for the amplifier titled "Amplifier2" and then select the "Calibrate Directional Coupler" function.
6. The calibration configuration editor opens. You can carry out the calibration just as you would for a signal path. Be sure to use a high enough signal generator level (> 10 dBm) so as to operate outside the noise level of the RF sensor. Also all ports on the directional coupler must be terminated with 50 Ohm.
7. Carry out steps 1 – 6 for amplifier 3.

## 5.2.7 Reference Calibration with Field Uniformity Evaluation of the Log-Periodic Antenna

Part of the reference calibration procedure establishes the antenna input power and generator level needed for producing the required field strength at the field sensor for each frequency point. This result is then saved to a Reference Calibration Table type of file.

To measure field uniformity, place the field sensor at 16 different predefined positions in a level space measuring 1.5m x 1.5m located at a distance of 3m in front of the tip of the antenna. Carry out a reference calibration sequence for each individual sensor position. You also need to take this measurement for each polarization of the antenna.

Detailed instructions for carrying out reference calibration can be found in the online help, "*Application Notes → EN 61000-4-3 → Field Uniformity Calibration*".

As a result of this field uniformity evaluation you obtain a reference calibration file containing the antenna input power needed to give the desired S/N ratio. This file is subsequently used in the equipment test.

## 5.2.8 Equipment Test with EUT Monitoring

Before carrying out the equipment test, place the EUT in the middle of the field uniformity area and remove the field sensor.

Detailed instructions for carrying out an equipment test can be found in the "Getting Started" manual for the EMC32 application or in the online help in the chapter on *EMS Measurement* or in the online help, "*Application Notes → EN 61000-4-3 → Equipment Test*".

The reference calibration (field uniformity evaluation result) generated in the previous step is to be used during the test equipment measurement. If you also wish the EUT to be monitored during the test via the EUT monitoring TTL interface built into the R&S IMS, you can use for this purpose the EUT monitoring configuration "DIO Monitoring" generated by the R&S IMS configuration wizard.

In this case a 10 ms pulse is generated on line 1 (pin 1) of the output port (port 4 in the EMC32 IMS DIO driver) at each test frequency. The status of line 3 (pin 8) of the input port (port 3 in the EMC32 IMS DIO driver) is also monitored. The pin assignment for the EUT monitoring interface can be found in chapter 6.2 Instrument Interfaces.

Further details on the EUT Monitoring topic can be found in the chapter "*Fundamentals – Test Template Editors – EUT Monitoring*" in the EMC32 online help.



## 5.3 Measurement to EN 61000-4-6 (Conducted) with CDN

This chapter describes the use of the R&S IMS for measurements to generic standard EN 61000-4-6. Depending on the EUT used, the standard requires the S/N ratio level to be coupled to one of the transducer instruments in the following list:

- Coupling/decoupling network (CDN)
- EM coupling clamp
- Bulk-current injection clamp (BCI)

For further information on the rules for selecting the suitable coupler please refer to the appropriate chapter in the published standard.

The test using coupling/decoupling networks is described below. The coupling/decoupling network types used in this case are determined by the interfaces on the test equipment (e.g. M2, M3, AF). However, the same configuration is used for the software and test setup regardless of type.

EMS tests using the EM coupling clamp or the bulk-current injection clamp require an external amplifier, since the power of the internal 25 W amplifier is not adequate for an S/N ratio of 10 V.

---

**Note:** *A dialog with the instruments is only possible when the interlock is closed. Contacts 1 and 3 of the 25 pin D-Sub INTERLOCK on the IMS have to be connected for that. See tab. 1-2 for the pin assignments.*

---

### 5.3.1 Test Setup

This measurement uses the R&S IMS instrument with the built-in 25 W amplifier covering a frequency range of 9 kHz to 250 MHz. The amplifier has enough power for tests to be carried out at a test level of 10 V.

The illustration below shows how the system can be configured using few additional components:

- R&S NRP-Z91 RF sensor with NRP-Z4 USB adapter
- 6 dB RF attenuator with minimum 25 W power drain
- CDN with appropriate calibration adapter (other types are also possible)
- RF and USB cable set
- System process controller with R&S IMS operating system (EMC32)

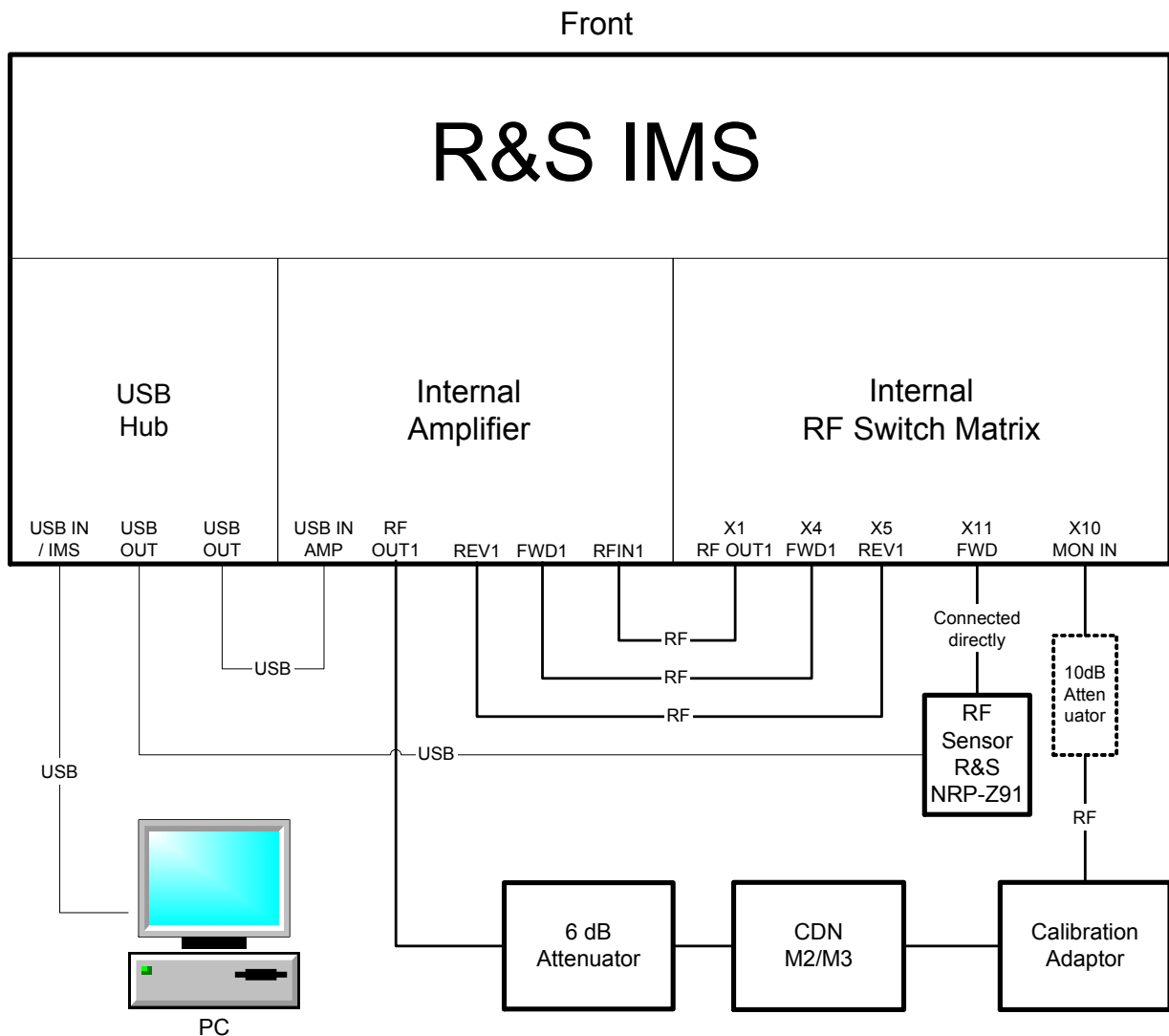

Fig. 5-11 Test setup to EN 61000-4-6 with a coupling/decoupling network in a one RF sensor configuration

The above figure shows the system setup for calibrating the coupling/decoupling network CDN. During subsequent test equipment measurement the calibration adaptor is replaced by the EUT itself. Because of the PIN diode switch integrated in the R&S IMS, the system can be operated using one RF sensor. This switches the input for the forward RF power, the input for the reflected RF power and the input for the monitor input RF signal to the RF sensor as appropriate.

### 5.3.2 Software Configuration

In the first step after installing the EMC32 operating system software for the R&S IMS, you have to adapt the software to your system. This means you must tell the EMC32 software which instruments are present in your system, which interfaces are used to address them, how the instruments are interconnected and how it is intended that the measurements obtained via these instruments shall be carried out.

For this purpose the EMC32 software includes the **R&S IMS configuration wizard**, which prompts you for the instruments present in the system and then creates a standard configuration for the system. Correction tables and test templates are also copied to the appropriate folders.

To start the R&S IMS configuration wizard proceed as follows:

1. Start the EMC32 application.
2. If the opening dialog is enabled, you will see that it contains an icon that will open the wizard.

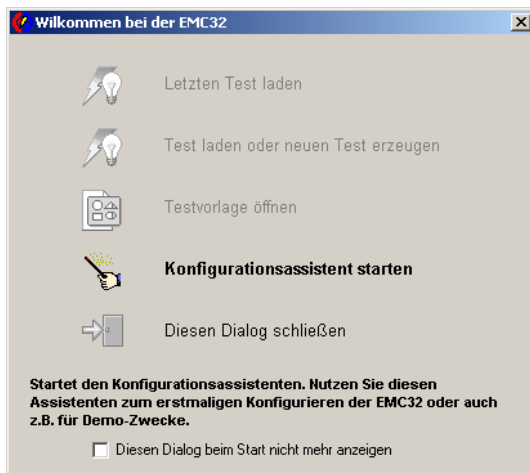

Fig. 5-12 Opening dialog for the EMC32 software

3. Otherwise open the wizard via the menu: **Extras – Wizard – IMS Configuration**.
4. The following dialog opens. Measurement class *EMS conducted* will be selected for EN 61000-4-6.

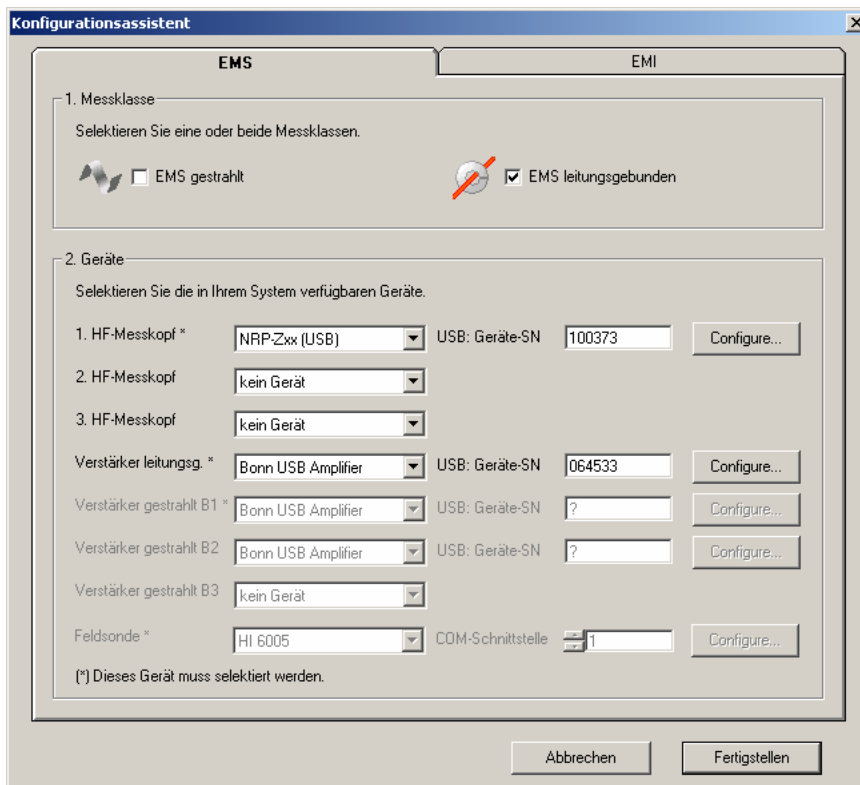

Fig. 5-13 Dialog in the R&S IMS configuration wizard (EMS conducted)

5. In this example the chosen configuration is One RF Sensor. Sensors 2 and 3 are therefore not selected. The serial number of the R&S NRP-Z91 sensor that will be used can be entered in the

USB Instrument SN field. If this number is not known, a '?' can be entered. When using a different sensor from the NRP-Zxx product family, this can be changed in the *Configure...* dialog.

6. Lastly enter the serial number of the internal amplifier that will be controlled via the USB port. To use an external amplifier, select Generic Amplifier as the amplifier type in place of the Bonn USB amplifier type. The amplifier parameters can be adapted in the *Configure...* dialog.



Fig. 5-14 Configuration dialog for the conducted amplifier

7. Having completed all the entries, click on the **Finish** button to run the configuration procedure.
8. When the configuration wizard has closed, the EMC32 application must be restarted.

**Note:**

*The EMC32 software is now ready to begin the first demo measurement. Before you can carry out the first test equipment measurement, it is necessary to calibrate the signal paths and the coupling/decoupling network.*

9. As well as the configuration for measuring with the aid of coupling/decoupling networks, the wizard also creates a configuration for calibrating the bulk-current injection clamp, for measuring with the current clamp and for an amplifier test on the conducted amplifier. For more details on these configurations please refer to the Application Notes for EN 61000-4-6 in the EMC32 online help.
10. The wizard creates an EMC32 list of equipment containing the following instruments:

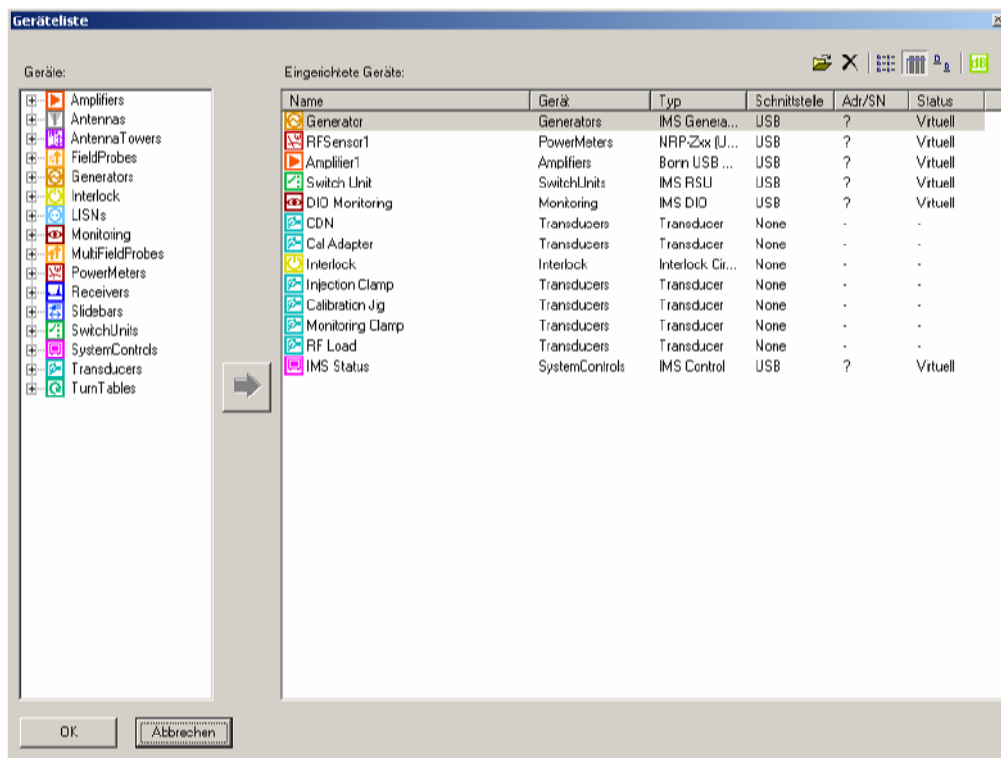

Fig. 5-15 Equipment list created by the configuration wizard for EMS conducted

The following list contains short descriptions of the device driver functions:

Instrument name	Description
Generator	For controlling the internal R&S IMS generator module
RFSensor1	For controlling RF sensor NRP-Z91
Amplifier1	For remote control of the internal amplifier module
Switch Unit	For controlling the internal RF switching matrix
DIO Monitoring	For controlling the R&S IMS EUT Monitoring interface for test equipment monitoring and stimulation
CDN	For defining the physical limit values of the coupling/decoupling networks. In this case the 6 dB attenuator is defined as the fixed value.
Cal Adapter	For defining the physical parameters of the calibration adapter. The value of 1/6 required for measuring $U_0$ is defined here as a constant attenuation of 15.56 dB.
Interlock	For monitoring the interlock input
Injection Clamp	For defining the physical limit values of the bulk-current injection clamp for BCI measurements
6	For defining the physical parameters of the calibration adapter referenced to the bulk-current injection clamp and required for calibration. The value of 1/2 required for measuring $U_0$ is defined here as a constant attenuation of 6 dB.
Monitoring Clamp	For defining the physical parameters of the monitoring clamp for BCI measurements. The transmission characteristic of the clamp must be either calibrated or entered in a transducer table. For details please refer to the Application Note EN 61000-4 in the EMC32 online help.
RF Load	For defining the physical limit values of the RF terminating impedance for the amplifier test
IMS Status	For controlling the R&S IMS status display on the front panel

Table 5-5 List of the instruments entered in the equipment list by the configuration wizard

### 5.3.3 Signal Path Calibration

In the second step the supplementary RF cable must be calibrated in order to increase measurement accuracy. This is done with the aid of the signal path calibration tools incorporated in the EMC32 software.

**Note:** *With the option R&S IMS-B3 included, the interlock needs to be closed for calibrations in order to allow the generator level to appear at the outputs RF OUT 1 to RF OUT 3/IMS.*

During signal path calibration the frequency-dependent damping behavior of a signal path in the test system is determined and saved to a file of the *damping correction table* type. The settings used when measuring a signal path are held in a file of the *calibration configuration* type. A dedicated dialog box has been provided for defining these settings.

There are two possible ways of opening this dialog:

- From the Explorer by double-clicking on an existing calibration configuration or by clicking once with your right mouse button on the Calibration Configurations folder and clicking once on **New File** in the context menu.
- By clicking on the **Calibration** button in the Properties dialog of a signal path that has been called out from an instrument configuration. This call has been provided so that an instrument configuration can be fully and consistently created in a single process. If a number of correction tables are specified, a selection dialog opens first so that you can select the table requiring calibration.

The following signal paths require calibration for this measurement application:

Path name	From	To	Remarks
Generator-Amplifier1	Output of the internal generator module	Input of the internal amplifier module	Correction table on accompanying CD-ROM
Amplifier1-RFSensor1(FWD)	Output of the internal amplifier module FWD1	Output X11 FWD via internal directional coupler	Correction table on accompanying CD-ROM
Amplifier1-RFSensor1(REV)	Output of the internal amplifier module FWD1	Output X11 FWD via internal directional coupler	Correction table on accompanying CD-ROM
Amplifier1-CDN	Cable at AMP OUT 1 output	Cable at CDN input	Calibration without 6 dB attenuator
CAL Adapter-RFSensor1	Cable at calibration adapter output	Cable at X10 MON IN input	

Table 5-6 List of signal paths

The first three signal paths in the above table cannot be calibrated without opening the R&S IMS. The attenuation correction tables are therefore included in the CD-ROM as files. To import these tables proceed as follows:

1. In the EMC32 Explorer expand the tree system for Correction Tables and look for the Attenuation entry.
2. Right click on the Attenuation entry and select the Import From entry from the popup menu.
3. A file selection dialog opens. Select the required table and import it by clicking the Open button.
4. Carry out steps 2 and 3 for all three of the above mentioned tables.

To calibrate the last two signal paths from the above table (including the external RF cable), proceed as follows:

5. From the EMS conducted instrument configuration open the "CDN (EM-Clamp)" file.
1. Left click on the icon for the signal path "Amplifier1-CDN" in order to open the Properties dialog of that signal path.
2. Start signal path calibration by clicking on the Calibration radio button in the dialog. All settings for calibration in the signal path calibration editor are already preconfigured. Start calibration by pressing the *Calibration* button.
3. For normalization connect the RF sensor to output X1 RF OUT 1/IMS.
4. For signal path measurement insert the cable between output AMP OUT 1 and CDN, without the 6 dB / 3 dB attenuator, between output X1 RF OUT 1/IMS and the RF sensor. This attenuator is inserted in the Properties CDN of the device list as a fixed value. Please adjust the value in case you are using another attenuator in the path to the CDN. For more detailed information on using the signal path calibration tools in EMC32, please refer to the chapter *System Calibration – Signal Path Calibration* in the EMC32 online help.
5. Proceed in the following way to calibrate the "CAL Adapter-RFSensor1" signal path:
6. Normalization is carried out as in step 3.



When testing the EUT with 6 V or 10 V the pin diode switch can be damaged by applying too high levels from the CDN calibration adapter to the MON IN input X10 during reference calibration. Please use a 10 dB attenuator connected to X10 MON IN and included in the cable calibration as remedy (see fig. 5.11).

**ATTENTION !** When calibrating the path "CAL Adapter-RFSensor1" in addition to the cable also the attenuator has to be connected to X10.

7. For the calibration the cable between the output X10 MON IN and the calibration adapter is to be measured. It has to be connected between the output X1 RF OUT1/IMS via the recommended 10 dB attenuator to X10 MON IN. The RF power sensor is connected to X11.

### 5.3.4 Reference Calibration of Coupling/Decoupling Networks

Part of the reference calibration procedure establishes the CDN input power and generator level needed for producing the required voltage at the CDN output for each frequency point. This result is then saved to a Reference Calibration Table type of file.

The reference calibration must be carried out separately for each RF coupling/decoupling network type in use and saved to a separate reference calibration table. The test template "EN61000-4-6 CDN" prepared by the configuration wizard is to be used for calibration.

Detailed instructions for carrying out the reference calibration can be found in the "Getting Started" manual for the EMC32 application or in the online help in the chapter "System Calibration – Reference Calibration".

### 5.3.5 Equipment Test with Coupling/Decoupling Network and EUT Monitoring

Before carrying out a test equipment measurement you must first connect the EUT to the output of the coupling/decoupling network CDN. The calibration adapter is no longer needed and can be removed along with the RF cable.

Detailed instructions for carrying out the equipment test can be found in the "Getting Started" manual for the EMC32 application or in the online help in the chapter "EMS Measurement".

The reference calibration generated in the previous step is to be used for the respective coupling/decoupling network during the test equipment measurement. If you also wish the EUT to be monitored during the test via the EUT monitoring TTL interface built into the R&S IMS, you can use for this purpose the EUT monitoring configuration "DIO Monitoring" generated by the R&S IMS configuration wizard.

In this case a 10 ms pulse is generated on line 1 (pin 1 of the MONITORING socket) of the output port (port 4 in the EMC32 IMS DIO driver) at each test frequency. The status of line 3 (pin 8 of the MONITORING socket) of the input port (port 3 in the EMC32 IMS DIO driver) is also monitored. The pin assignment for the EUT monitoring interface can be found in chapter 6.2 Instrument Interfaces.

Further details on the EUT Monitoring topic can be found in the chapter "Fundamentals – Test Template Editors – EUT Monitoring" in the EMC32 online help



# 6 Instrument Interfaces, Maintenance, Errors

## 6.1 Introduction

This section deals with the instrument interface and gives an overview of the error displays which appear on the R&S IMS.

## 6.2 Instrument Interfaces

Entry in column D (direction):  
Entry in column T (type):  
Entry in column TT  
(test & trimming instructions)

O = output                    I = input                    B = bidirectional  
A = analog                    D = digital                    P = power  
P = test value                T = trimming value  
D = design value              E = setting value

	D	T	Value range	TT	Connector	Comment
RF output 1	O	A	9 kHz to 3 GHz -127 dBm - +13 dBm	P -	X1 RF OUT 1/IMS	Generator output via relay K1
RF output 2	O	A	9 kHz to 3 GHz -127 dBm - +13 dBm	P -	X2 RF OUT 2/IMS	Generator output via relay K1
RF output 3	O	A	9 kHz to 3 GHz -127 dBm - +13 dBm	P -	X3 RF OUT 3/IMS	Generator output via relay K1
Measurement input of the forward power, amp. 1	I	A	9 kHz to 3 GHz -70 dBm - +13 dBm	P -	X4 FWD1	from directional coupler of amp. 40dB decoupl.
Measurement input of the forward power, amp. 2	I	A	9 kHz to 3 GHz -70 dBm - +13 dBm	P -	X6 FWD2	from directional coupler of amp. 40dB decoupl.
Measurement input of the forward power, amp. 3	I	A	9 kHz to 3 GHz -70 dBm - +13 dBm	P -	X8 FWD3	from directional coupler of amp. 40dB decoupl.
Measurement input of the reflected power, amp. 1	I	A	9 kHz to 3 GHz -70 dBm - +13 dBm	P -	X5 REV1	from directional coupler of amp. 40dB decoupl.
Measurement input of the reflected power, amp. 2	I	A	9 kHz to 3 GHz -70 dBm - +13 dBm	P -	X7 REV2	from directional coupler of amp. 40dB decoupl.
Measurement input of the reflected power, amp. 3	I	A	9 kHz to 3 GHz -70 dBm - +13 dBm	P -	X9 REV3	from directional coupler of amp. 40dB decoupl.

	D	T	Value range	TT		Connector	Comment
Monitor input	I	A	9 kHz to 3 GHz -70 dBm - +13 dBm	P	-	X10 MON IN	Monitor signal from test clamp or sensor
Measurement output for first R&S NRP-Z91 power sensor	O	A	9 kHz to 3 GHz -70 dBm - +13 dBm	P	-	X11 FWD	all measurement signals are applied via switch K4 (FWD, REV, MON IN); with option R&S IMS-B7 FWD only
Measurement output for second R&S NRP-Z91 power sensor R&S IMS-B7	O	A	9 kHz to 3 GHz -70 dBm - +13 dBm	P	-	X12 REV	measurement signals (REV, MON IN) are applied via switch K4
Signal input for optional analyzer R&S IMS-B1	I	A	9 kHz to 3 GHz -70 dBm - +20 dBm	P	-	X13 ANALYZER	
Reserve						X14 MON OUT	Reserve
LF generator output	O	A	20 Hz to 20 kHz 1mV -2V rms	P	-	X21	
Ext. REF input of generator	I	A	10 MHz, 0.5 V to 2 V on 50 Ω	P	-	X22	
Ext. REF output of generator	O	A	10 MHz, >0.5 V on 50 Ω	P	-	X23	
Ext. REF input of optional analyzer	I	A	10 MHz, 0.5 V - 2 V on 50 Ω	P	-	X24	
Ext. modulation input of generator	I	A	20 Hz to 20 kHz for AM 20 Hz to 80 kHz for FM	P	-	X25	also DC also DC
Ext. pulse modulation input of generator	I	A	100 μs to 1 s pulse width 200μs to 2s pulse period	P	-	X26	external AC/DC
RF input of int. amplifier 1	I	A	9 kHz to 3 GHz -127 dBm to +13 dBm	P	-	RF IN1	model 04 only
Measurement output of the forward power, amp. 1	O	A	9kHz to 3 GHz -70 dBm to +10 dBm	P	-	FWD1	from directional coupler of amp. 40dB decoupl.
Measurement output of the reflected power, amp. 1	O	A	9 kHz to 3 GHz -70 dBm to +10 dBm	P	-	REV1	from directional coupler of amp. 40dB decoupl.
RF output 1 of int. amplifier 1	O	A	9 kHz to 3 GHz -16 dBm to +44 dBm	P	-	AMP OUT 1	in model 04 / with opt. R&S IMS-B2
RF output 2 of int. amplifier 1	O	A	9 kHz to 3 GHz -16 dBm to +44 dBm	P	-	AMP OUT 2	in model 04 with opt. R&S IMS-B2
RF input of int. amplifier 2	I	A		P	-	RF IN2	not assigned at present

	D	T	Value range	TT		Connector	Comment
Measurement output of the forward power, amp. 2	I	A		P	-	FWD2	not assigned at present
Measurement output of the reflected power, amp. 2	I	A		P	-	REV2	not assigned at present
Remote control input of the R&S IMS from the host computer	B	D	USB connection, version 2.0	D	-	USB IN / IMS	Type "B" connector
Remote control input of the R&S IMS for sensor, amplifier, iKey	B	D	USB connection, version 2.0	D	-	USB OUT	8 pcs type "A" connector
Remote control input of the amplifier	B	D	USB connection, version 2.0	D	-	USB IN / AMP	Type "B" connector model 04 only
Monitor connection to EUT	I	D	TTL IN, +5 V	P	-	Monitoring Pin 1, 2, 3, 4	Input
Monitor connection to EUT	B	A	Ground	D	-	Monitoring Pin 5	Ground
Monitor connection to EUT	O	D	TTL OUT, +5 V	P	-	Monitoring Pin 6, 7, 8, 9	Output
						Remote Control Interlock Control	<b>Amplifier side 15 pin D-Sub</b>
Interlock	I	A	floating contact	P	-	Pin 8	
Interlock	I	A	floating contact	P	-	Pin 15	
Ground	B	A	Ground	D	-	Pin 7, 14	
Status RF IN	O	A	CMOS, approx. 12 V	P	-	Pin 2	
Status Sum Alarm	O	A	CMOS, approx. 12 V	P	-	Pin 6	
						Interlock	<b>R&amp;S IMS side 25 pin D-Sub</b>
Interlock to test room door	O	A	+12 V, 0.2 A	P	-	Pin 1	Contact to interlock switch on test room door
Interlock from test room door	I	A	Relay contact + LED	P	-	Pin 3	Contact to interlock switch on test room door
Interlock to amplifier 1	O	A	floating contact	P	-	Pin 8	Contact for interlock message to amplifier 1

	D	T	Value range	TT		Connector	Comment
Interlock to amplifier 1	O	A	floating contact	P	-	Pin 15	Contact for interlock message to amplifier 1
Interlock to amplifier 2	O	A	floating contact	P	-	Pin 7	Contact for interlock message to amplifier 2
Interlock to amplifier 2	O	A	floating contact	P	-	Pin 14	Contact for interlock message to amplifier 2
Interlock to amplifier 3	O	A	floating contact	P	-	Pin 6	Contact for interlock message to amplifier 3
Interlock to amplifier 3	O	A	floating contact	P	-	Pin 13	Contact for interlock message to amplifier 3
Test in Progress	O	A	floating contact	P	-	Pin 10	Contact to the indicator light
Test in Progress	O	A	floating contact	P	-	Pin 11	Contact to the indicator light
Message from amplifier 1 "RF IN"	I	A	approx. +12 V, CMOS	P	-	Pin 5	Message goes to front LED of R&S IMS
Message from amplifier 1 "General interference"	I	A	approx. +12 V, CMOS	P	-	Pin 12	Message goes to front LED of R&S IMS
Message from amplifier 2 "RF IN"	I	A	approx. +12 V, CMOS	P	-	Pin 9	Message goes to front LED of R&S IMS
Message from amplifier 2 "General interference"	I	A	approx. +12 V, CMOS	P	-	Pin 4	Message goes to front LED of R&S IMS
Message from amplifier 3 "RF IN"	I	A	approx. +12 V, CMOS	P	-	Pin 17	Message goes to front LED of R&S IMS
Message from amplifier 3 "General interference"	I	A	approx. +12 V, CMOS	P	-	Pin 16	Message goes to front LED of R&S IMS
Ground	B	A	Ground	D	-	Pin 2, 24, 25	
Amp. 1 "RESET"	O	D	TTL OUT, 5V,	P	-	Pin 18	Command to external amplifier 1 with parallel interface
Amp. 1 "OPERATE"	O	D	TTL OUT, 5V,	P		Pin 19	Command to external amplifier 1 with parallel interface

	D	T	Value range	TT		Connector	Comment
Amp. 1 "REMOTE"	O	D	TTL OUT, 5V,	P		Pin 20	Command to external amplifier 1 with parallel interface
Amp. 2 "RESET"	O	D	TTL OUT, 5V,	P	-	Pin 21	Command to external amplifier 2 with parallel interface
Amp. 2 "OPERATE"	O	D	TTL OUT, 5V,	P		Pin 22	Command to external amplifier 2 with parallel interface
Amp. 2 "REMOTE"	O	D	TTL OUT, 5V,	P	-	Pin 23	Command to external amplifier 2 with parallel interface
AC supply	I	P	100 V to 240 V, 50 Hz to 60 Hz, max. 110 VA model 02 max. 280 VA model 04	D	-	Power plug	

## 6.3 Maintenance

No special maintenance action is necessary for the R&S IMS.

**Mechanically** care should be taken to ensure that the fans can deliver the cooling air unhindered. The air intake aperture at the front of the side panel on the left of the housing, viewed from the front, should therefore be checked occasionally for accumulation of dust and cleared if necessary. Similarly any accumulation of dust in the air outlet apertures should also be cleaned.

The air duct on the integral amplifier should simply be checked as a whole and brushed out if necessary.

Filter mats are not used in the R&S IMS.

**Electrically** just check that all connecting cables are in their proper control side and RF side places and make any necessary correction.

## 6.4 Error Displays

The error displays which appear on the R&S IMS are hardware controlled and have the following meanings (see Fig. 1-1):

### POWER LED 4

**green** when all operating voltages are within tolerance.

**red** when one or more operating voltages are out of tolerance.

### INTERLOCK LED 5

**green** when the interlock circuit is closed; all connected amplifiers are ready to operate.

Built-in option R&S IMS-B3 is activated, i.e. the amplifier input is connected to the generator output.

**red** when the interlock circuit is open; none of the connected amplifiers can be switched to Operate.

Built-in option R&S IMS-B3 is deactivated, i.e. the amplifier input receives a 50 Ohm termination.

The PAX LED also shows red when an amplifier is connected in the event of an open interlock.

### PAX LED 9 (with amplifiers supplied by the Bonn company only)

**green** when the amplifier has received the RF IN command and also switches to Operate.

**red** when there is a sum error in the amplifier (also including an open interlock).

---

# 7 Amplifier Manual

This section only applies to R&S IMS Var. 04 where there is an integrated amplifier.

## 7.1 Preparation for Use



### ***Pay Attention to the Operating Instructions!***

*During operation there may be a hazard due to electromagnetic fields.  
(According to Part 2 of VDE 0848)!*

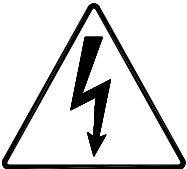

### ***Dangerous Electric Voltages!***

*During open-circuit operation, the voltage at the centre conductor of the output connector may exceed 50 V AC.*

**Warning!** *This device generates RF power, which can be emitted unintentionally if the operating instructions and the general safety regulations are not observed!*

*This amplifier corresponds to rating class 1A according to VDE 0800. The AC voltage at the output is  $\leq 60$  Vrms.*

*According to annex 1 of the Amtsblattverfügung Nr. 243/1991 (operating regulations gazette of German PTT) of 11th December 1991, Allgemeingenehmigung nach dem Gesetz über den Betrieb von Hochfrequenzgeräten (general permit according to the law on use of high-frequency devices) the following must be considered:*

*Signal or test generators with an RF power supplied via connectors and exceeding 4 W (PEP - Peak Envelope Power) must be operated inside RF-shielded rooms!*



### 7.1.1 Setting up the amplifier

When setting up the amplifier, make sure that the cooling airflow is impeded neither at the air inlet at the front nor at the outlet at the rear. The permissible operating temperature ranges from +5°C to +45°C with an air humidity of max. 95%. The outlet air temperature exceeds the inlet temperature by max. 20°C.

**Caution!** *The temperature of the inlet cooling air must not exceed +45 °C. The outlet air temperature should be maximum 20 °C higher than the inlet air temperature.*

### 7.1.2 Rack mounting

To ensure sufficient ventilation, make sure to provide enough space between the casing and the air inlet at the front panel and the air outlet at the rear. Make sure that there is sufficient air supply inside the rack (forced ventilation) and that no overheating can occur due to other instruments placed under or over the amplifier.

**Caution!** *The temperature of the inlet cooling air must not exceed +45 °C.*

### 7.1.3 Mains connection

The amplifier is equipped with a power supply which can be operated at a voltage of 100 ... 240 V AC.

**Note:** *When connecting the amplifier to the AC mains network, make sure to provide a proper protective earth connection according to the regulations.*

### 7.1.4 RF connectors

The amplifier is equipped with N- or SMA-type female connectors at all RF connectors. The mating connectors must be tightened manually!

## 7.1.5 Interlock safety loop

This amplifier permits an interlock safety loop to be connected, which must be always closed for activating the amplifier. The interlock function protects the user against unintentional emission of RF power.

It is necessary to wire the attached mating connector for the Remote Control and Interlock connector at the rear panel of the instrument as shown below. Pin 8 and pin 15 should be connected to the safety loop of the measuring room.

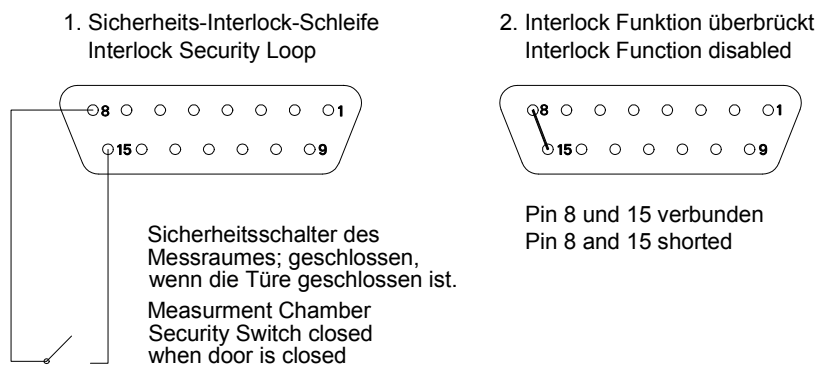

Fig. 7-1 Pin assignment of remote control and interlock connector

This ensures that the amplifier can only be switched on when the safety switch, and thus the door of the measuring room, is closed.

The EXTERNAL INTERLOCK and EXTERNAL INTERLOCK RETURN contacts are designed as floating ones. In this way more than one amplifier can be interconnected in an interlock system with a common switch or a common loop.

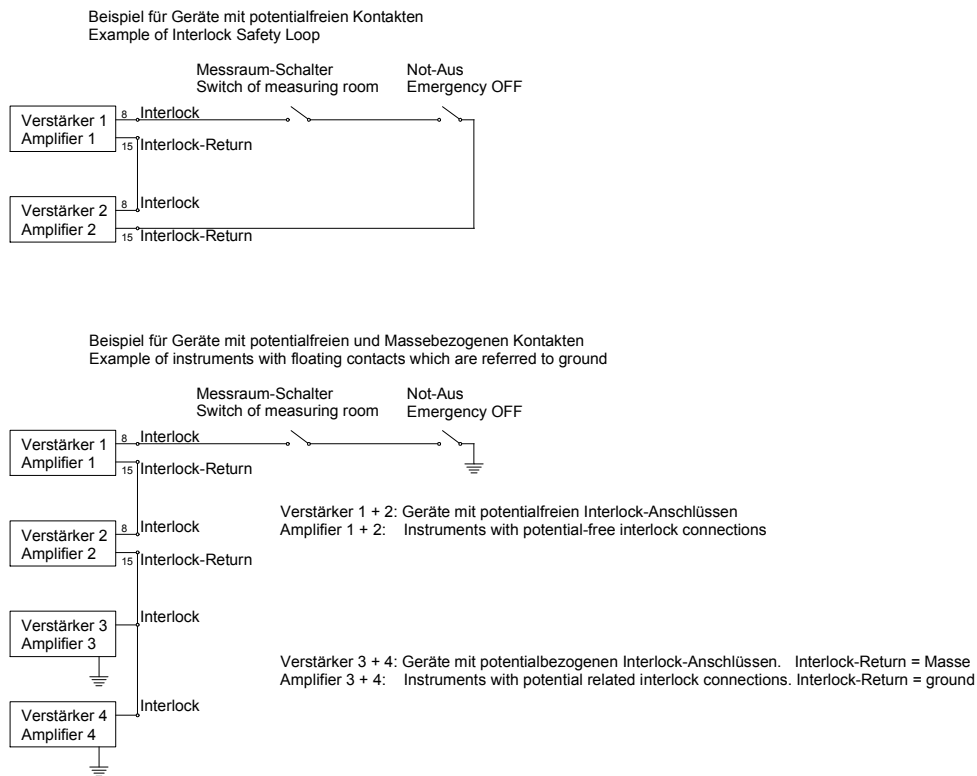

Fig. 7-2 Example of interlock safety loop

If this safety function is not used after thorough examination, the interlock contact can be bridged in the Remote Control and Interlock connector. This is done using a jumper from EXTERNAL INTERLOCK pin 8 to EXTERNAL INTERLOCK RETURN pin 15.

**Note:** *If the interlock connection is missing, the amplifier cannot be operated!*

Finally check that there is no message indicating an interlock error status on the display. Now the amplifier is ready for use and can be operated either manually via the front panel or via one of the remote control interfaces.

## 7.2 Functional Description

### 7.2.1 RF amplifier

See Fig. 25: Block diagram of complete amplifier (in appendix)

See Fig. 26: Block diagram of RF amplifier module (in appendix)

The power amplifier BSA 0125-25I can deliver an output power of 25 W over the frequency range of 9 kHz to 250 MHz.

The five-stage solid-state amplifier is integrated into one module.

The preamplifier is implemented with MIC components (microwave integrated circuits). They ensure high overload immunity and a low VSWR at the input of the amplifier. Three MIC components will amplify the input signal with a flat overall frequency response. The signal of the input stage is split up with 180° phase offset between the two MIC components of the driver stage.

The input stage is decoupled from the input DC voltage via a coupling capacitor. Due to the high linearity over the wide frequency range of the MIC component used, a frequency-dependent negative feedback is not required. The following stages, on the other hand, all feature an individually adjusted negative feedback, resulting in a flat overall frequency response.

The fourth (driver) stage is implemented using FET technology; working in class-A mode, driving the push-pull final stage using bipolar transistors working in class A mode to reduce distortion over the wide frequency range. Following the final stage the signal is recombined again by broadband combiners.

In order to achieve a stable output power, the bias of the FET and bipolar stages are controlled by low-drift voltage regulators.

The maximum input power for achieving the nominal output power is 0 dBm corresponding to 1 mW or 0.224 V into 50 Ω. Due to its gain reserve, the amplifier usually achieves full output power with an input power of -5 dBm.

The final stage is separately protected against overload by current limitation. The amplifier is protected against open circuit and short circuit at the output. By using suitable transistors and a special circuit design in the final stage, even a total mismatch at the output will not cause any damage. For a VSWR ≤ 2:1 the maximum power can be obtained, all specifications being met.

The amplifier housing is designed to ensure minimum RF leakage and high RF immunity. The module is supplied with DC voltage via RF feed through filters.

In order to protect the amplifier against thermal overload in case the blower fails or the ambient temperature is too high, a temperature sensor is mounted on the heat sink in the vicinity of the final stage.

## 7.2.2 Power supply

See Fig. 27: Block diagram of power supply (in appendix)

The power supply consists of a main power supply module with line filtering and auxiliary power supply modules.

### Line filtering

Mains phase and neutral are routed to the line filter via mains fuse and mains switch.

Radiated emissions are avoided by shielding and a special design of the wire connections. Conducted emissions are suppressed by a two stage filtering in the main power supply and the line filter at the mains input.

The radio interference suppression of the complete power supply meets the requirements of class B according to VDE 0871.

### Power supply

The main power supply is designed such as to work from an operating voltage range of 100 to 240 V. The front-end module filters the distortions caused by the power factor correction and the switched-mode controller.

The power supply is designed as a switched mode DC-DC converter using resonance converter technology and has an efficiency of >95%. In the front-end of the switched-mode power supply, the required correction of the power factor is integrated. The front-end module also limits the inrush current and provides a transient and over voltage protection.

After switching the instrument on with the mains switch the auxiliary power supply will be operating. It feeds the control circuitry of the amplifier and the power supply even if the outputs of the main power supply are disabled.

The communication between the main control board and the micro controllers on the power supply boards is made via the internal control bus system. All operating conditions or fault status messages are continuously polled and processed.

The power supply control is surveying the status of all DC-DC converter outputs in the power supply. An error status will be indicated by the respective fault message on the front panel display. As voltage and current of all outputs are continuously monitored a detailed problem diagnosis can be issued.

All DC-DC converter outputs have their own voltage regulation (over voltage protection) as well as an own current limitation circuit.

For optimum adaptation to the final stage transistors the current limitation for each individual transistor can be set directly by the micro controller.

Wherever possible and practicable power supply lines, control lines and RF modules are separated totally. This ensures a minimum of intersignal interference. Radiated emission is limited by the technique used for the RF modules. The conducted emission is limited by two stage filtering. The first filtering is done directly on the power supply modules where the final filtering is done at the AC input.

### **7.2.3 Monitor output (Option A)**

The monitor output is implemented with an internal dual directional broadband coupler for forward and reflected power at the connectors FORWARD and REFLECTED (as a standard at the rear panel).

### **7.2.4 USB remote control interface (Option U)**

The USB interface is integrated on a separate control board which directly communicates to the main control board.

### **7.2.5 Control**

The system control consists of a Bus-system with differential transmission. All boards of the system are connected to the control bus. The main control board will handle all status and fault messages and will control all other control and power supply boards.

## 7.3 Maintenance and Troubleshooting

### 7.3.1 Maintenance

In general, the amplifier does not require any maintenance due to its solid-state amplifier design and overrating of all components under thermal stress.

The fan has a lifetime  $\geq 40,000$  h; this results in a lifetime of 5 years even with permanent operation.

Cleaning and care of the RF connectors are to be performed according to the regulations valid for N- or SMA- series connectors. All mechanical and electrical specifications are guaranteed for at least 500 plug-in cycles.

For cleaning the front panel, it is best to use a moist, soft cloth and, if necessary, a mild detergent. Solvents must not be used.

### 7.3.2 Troubleshooting

If the instrument does not react at all please check the following.

- No response after switching the mains on: Check the mains voltage at the line input of the amplifier.

If a fault message will be indicated, the following should be checked:

- Indication: **Interlock External** Check the connection to the external interlock switch or jumper in the interlock connector (see Fig. 7-1).
- Indication: **Temperature X** Check whether the airflow is obstructed. Check if the internal blower works. Check if the ambient temperature is more than 45 °C. Allow the instrument to cool down and try to start again. Check if the Fault message persists.
- Indication: **PowerSupply X** Fault of one or more output voltages of the indicated power supply X. Switch off the amplifier and try to start again. Check if the Fault message persists.
- Indication: **Control fault** An internal control fault occurred. Switch off the amplifier and try to start again. Check if the Fault message persists.

If a non-permanent error message is being indicated it has to be confirmed by sending the RESET command before the fault status will be unlatched.

# 8 Index

AC Fuses .....	15
Analyzer Input .....	10
Applications .....	37
Autostart .....	22
<b>C</b>	
CD	
Installation .....	22
Update .....	28
Configuration .....	27
Configuration wizard .....	27, 51, 58
Connecting amplifiers .....	17
Connecting EUT monitoring .....	19
Connecting power sensors .....	17
<b>D</b>	
Data backup .....	31
Data security .....	21
<b>E</b>	
EUT monitoring	
Connecting .....	19
Examples of measurements .....	43
EXT MOD - Input .....	8
EXT pulse MOD - Input .....	8
EXT. REF OUT - Output .....	11
<b>F</b>	
Function checks .....	17
Fuse 7 .....	
Fuses .....	15
<b>G</b>	
GEN REF IN - Input .....	11
Generator output - LF .....	11
<b>I</b>	
iKey 25	
Input - EXT MOD .....	8
Input - EXT pulse MOD .....	8
Input - GEN REF IN .....	11
Input - REF IN Analyzer .....	8
Input Analyzer .....	10
Input for integral amplifier .....	11
Input MONITOR .....	10
Installation	
Device driver .....	23
Hardware .....	25
Software .....	22
Installing the operating system .....	20
Instrument functions .....	34
Instrument Interfaces .....	65
Interface - REMOTE CONTROL .....	12
Interface interlock .....	9
Interface monitoring .....	9
Interlock interface .....	9
<b>L</b>	
Language .....	26
LF generator output .....	11
<b>M</b>	
Measurement to EN 61000-4-3 (radiated) .....	43
Measurement to EN 61000-4-6 (conducted) with CDN .....	57
MON IN .....	10
Monitoring interface .....	9
<b>N</b>	
Network	
Installation .....	30
<b>O</b>	
Online Help .....	26
Output - EXT. REF OUT .....	11
Output for power sensor .....	9
Output from RF1 .....	12
Output from RF2 .....	12
<b>P</b>	
Power switch .....	7
<b>R</b>	
R&S IMS configuration wizard .....	45
Rack installation .....	13
REF IN Analyzer - Input .....	8
Registering the License .....	20
REMOTE CONTROL - interface .....	12
RF I/O for amplifier 1 .....	8
RF I/O for amplifier 2 .....	8
RF I/O for amplifier 3 .....	9
RF output .....	3
RF output 1 .....	12
RF output 2 .....	12
<b>S</b>	
Starting the program .....	26
System requirements .....	21
<b>T</b>	
Transfer relay .....	7
Troubleshooting .....	32
<b>U</b>	
Uninstalling .....	29
Update .....	28
USB - OUT interface .....	10
USB IN/AMP - interface .....	11
USB IN/IMS - interface .....	10
User administration .....	21
<b>W</b>	
Wizard .....	27, 45, 51, 58